

BB_DIGITAL

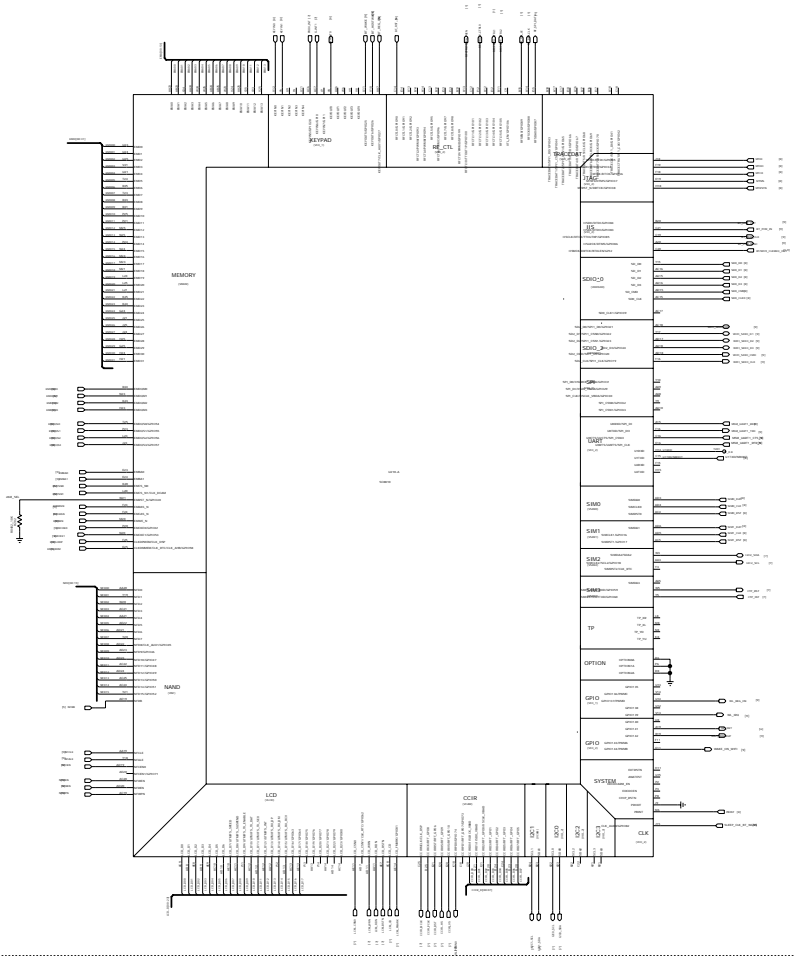

SHEET: BB_DIGITAL V.1.0	
Version	Hardware DCP1
Model No.	2011-01-16
Design No.	2011-01-16
Draw No.	2011-01-16

Spridnet Communications, Inc.

6 5 4 3 2 1

BB_ANALOG

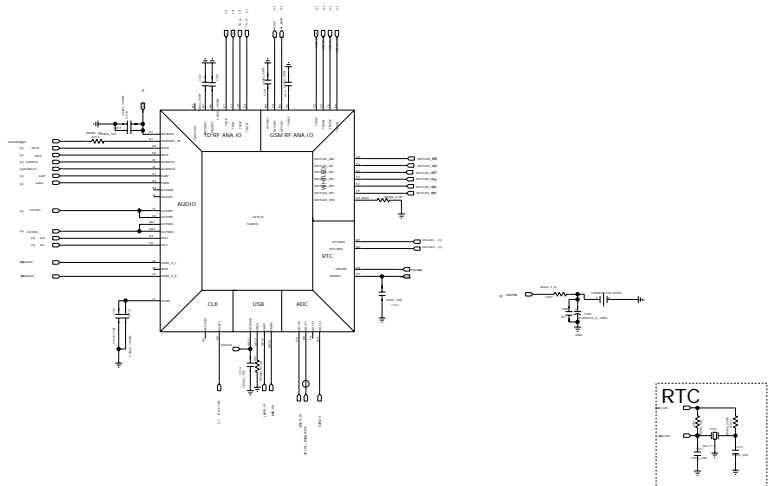

SPECTRUM COMMUNICATIONS, INC.	
SPECTRUM COMMUNICATIONS, INC.	
Model No.	2011-01-10
Revision No.	2011-01-10
Design No.	2011-01-10
Drawn By	2011-01-10

BB_POWER

BATTERY

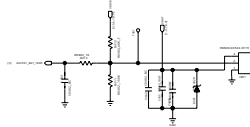

CHARGE

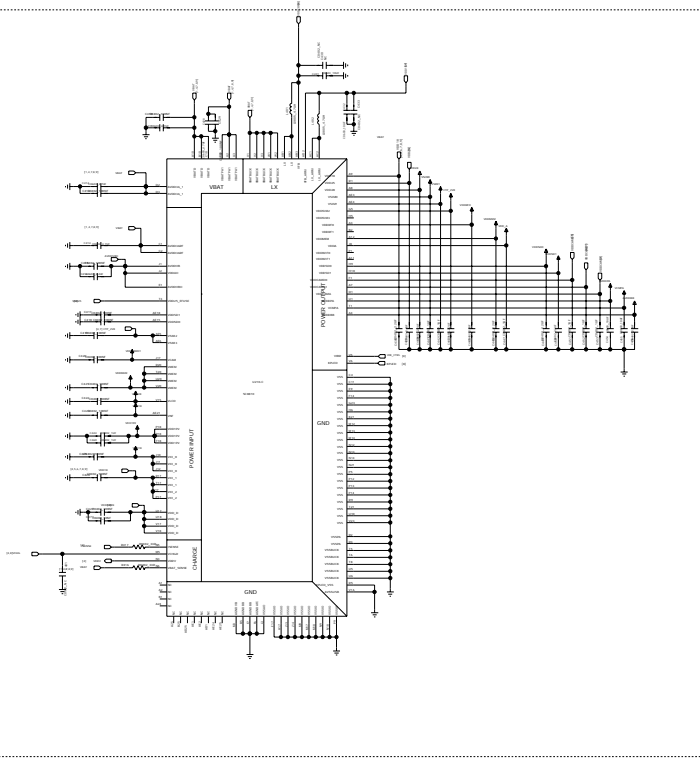
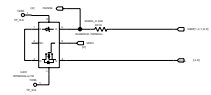

SPECTRUM COMMUNICATIONS, INC.			
SPECTRUM COMMUNICATIONS, INC.			
Version:	Rev. 001	Part No.:	SPC-1000-001
Created:	2001-01-16	Author:	Hardware Dept.
Checked:	2001-01-16	Appr.:	Spectrum Communications, Inc.
Released:	2001-01-16	Released To:	Customer/Supplier

6 5 4 3 2 1

MCP

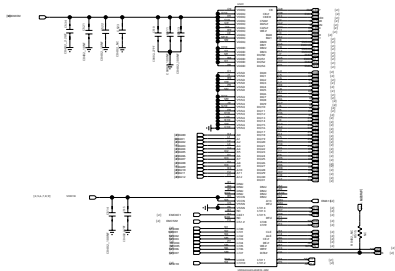

		SAMSUNG ELECTRONICS CO., LTD.	
Model No.	2011-01-16	Model No.	Standard DQPT
Design No.	2011-01-16	Design No.	Spradatum communications, Inc.
Rev. No.	2011-01-16	Rev. No.	

6 5 4 3 2 1

MIC CIRCUIT

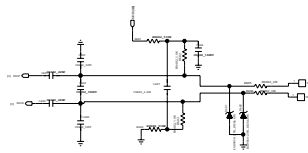

HEAD MIC

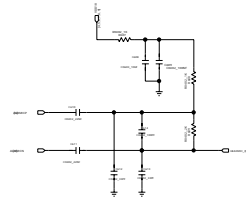

SPEAKER CIRCUIT

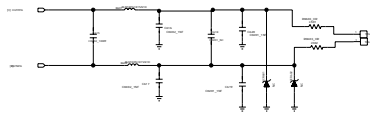

HEAD EAR



RECEIVER CIRCUIT

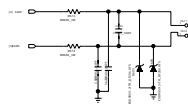

3.5mm Headphone Jack

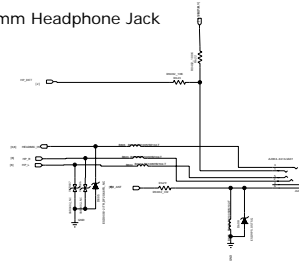

• • • •

SPECTRUM COMMUNICATIONS, INC.	
Spectrum Communications, Inc.	
Model No.	2011-01-16
Version	Hardware 0001
Company	Spectrum Communications, Inc.
Model No.	2011-01-16
Version	0001

Rev	1	Date	08/11/11
Author	SPR	Checked	SPR
Design	SPR	Approved	SPR

3.5" HVGA LCM

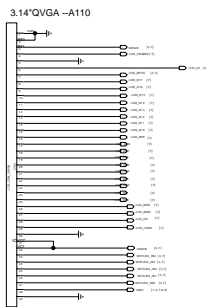
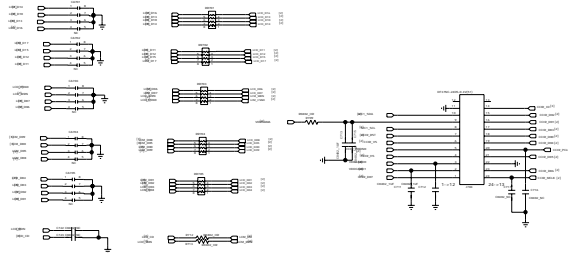
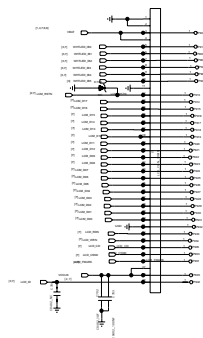

3.5" Capacitive TP

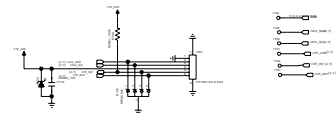

Ambient Light Sensor with Proximity Sensor

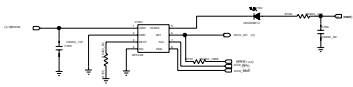

G Sensor

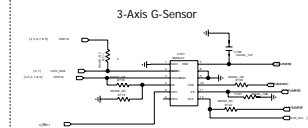

3.5" HVGA LCM			
Version	08/11/11	Author	SPR
Checked By	08/11/11	Checked	SPR
Design No.	08/11/11	Design	SPR
Rev	08/11/11	Approved	SPR

Project Name	Hardware DDP
Company	Spectrum Communications, Inc.
File Name	3.5" HVGA LCM

Rev	1	Date	2011-01-16
Author	Spectrum Communications, Inc.		
Checked	Spectrum Communications, Inc.		
Approved	Spectrum Communications, Inc.		

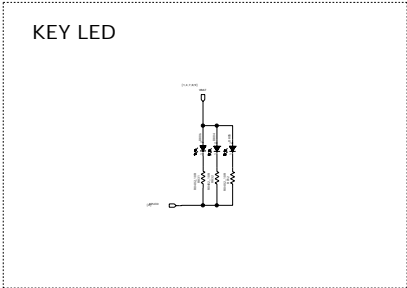
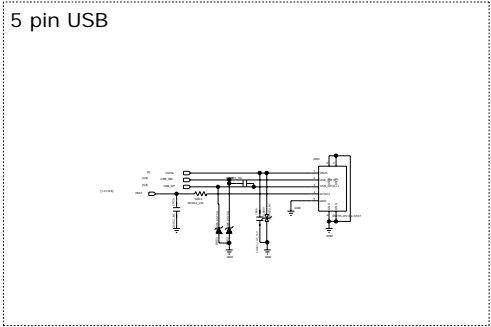
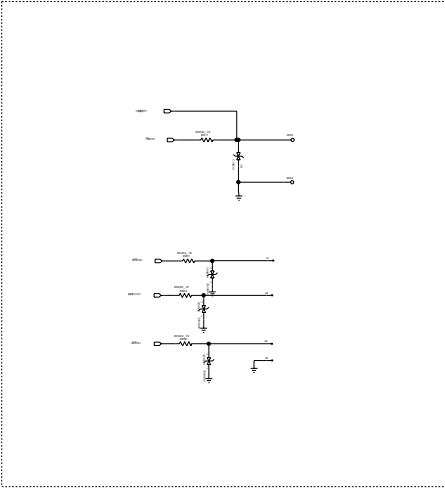
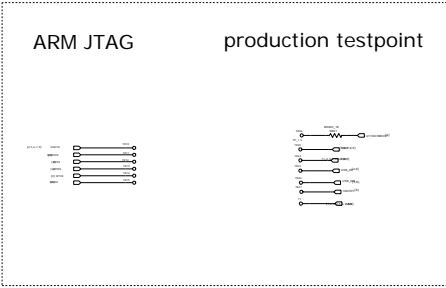
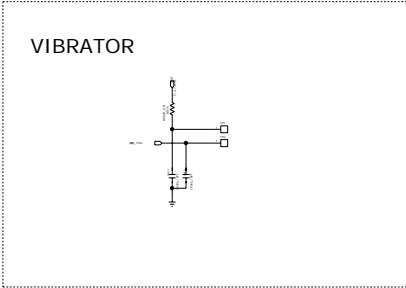
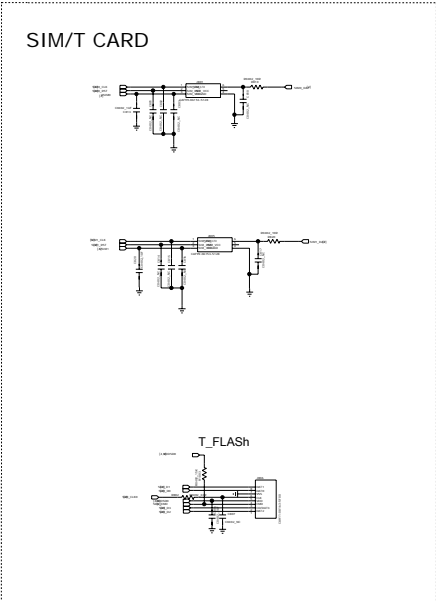

SPECTRUM COMMUNICATIONS, INC.			
Hardware BOM			
Rev	1	Date	2011-01-16
Author	Spectrum Communications, Inc.		
Checked	Spectrum Communications, Inc.		
Approved	Spectrum Communications, Inc.		

6 5 4 3 2 1

BCM4330_CONTROL

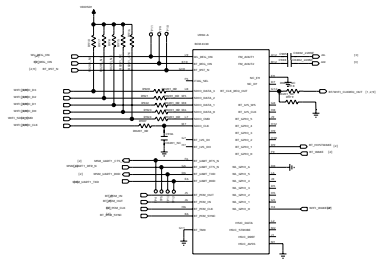

BCM4330_TRX

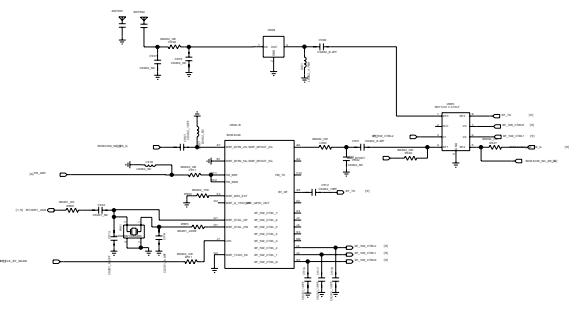

BCM4330_PWR

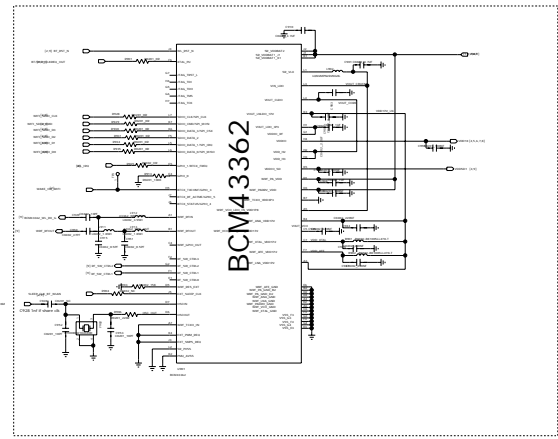
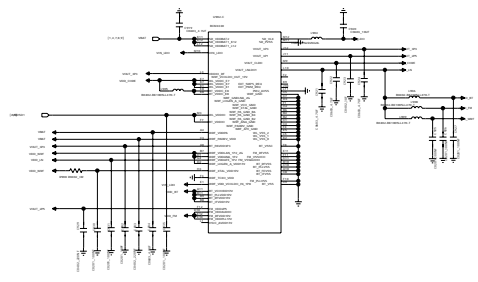

Version: 1.0
 Date: 2011-11-16
 Author: Hardware Design
 Company: Sprint Spectrum Communications, Inc.
 Project: BCM4330