



Sprint User Guide

A downloadable, printable guide to your Samsung Galaxy Note 7 and its features.

SAMSUNG
Galaxy Note7

Table of Contents

GETTING STARTED	1
Introduction	2
About the User Guide	2
Access Instructions on Phone	2
Access Help	2
Get Support from Sprint Zone	3
Set Up Your Phone	5
Parts and Functions	5
Maintaining Water and Dust Resistance	7
Charge the Battery	8
SIM Card	10
SD Card	11
Insert an SD Card	11
Unmount an SD Card	12
Remove an SD Card	12
Format an SD Card	13
Turn Your Phone On and Off	13
Use the Touchscreen	15
Activate Your Phone	18
Complete the Setup Screens	19
Smart Switch	20
Basic Operations	22
Basics	22
Home Screen and Applications (Apps) List	22
Phone Settings Menu	23
Portrait and Landscape Screen Orientation	23
Capture Screenshots	24
Edge Screen	24
S Pen	27
S Pen Options	28
Air View	28
Direct Pen Input	28
Screen Off Memo	29

Replace the S Pen Tip	29
Air Command	30
Create Note	31
Screen Off Memo	31
Smart Select	32
Screen Write	33
Translate	34
Add or Remove Air Command Shortcuts	35
Air Command Settings	37
Applications	37
Launch Applications	37
Apps List	38
Phone Number	42
Airplane Mode	42
Enter Text	42
Samsung Keyboard	42
Samsung Voice Input	44
Tips for Editing Text	45
Google Account	45
Create a Google Account	45
Sign In to Your Google Account	47
Factory Reset Protection	47
Google Play Store	48
Find and Install an App	49
Request a Refund for a Paid App	50
Update an App	50
Uninstall an App	51
Get Help with Google Play	52
Lock and Unlock Your Screen	53
Update Your Phone	53
Update Your Phone Software	54
Your Phone's Home Screen	57
Home Screen Basics	57
Home Screen Layout	57
Extended Home Screens	58
Status Bar and Notification Panel	58

Status Bar	58
Notification Panel	61
Search Device	64
Multi Window	65
Customize the Home Screen	66
Change the Wallpaper	66
Add Shortcuts to the Home Screen	67
Add Widgets to the Home Screen	68
Add Folders to the Home Screen	68
MAKING CONNECTIONS	70
Phone Calls and Voicemail	71
Place and Answer Calls	71
Call Using the Phone Dialer	71
Call Emergency Numbers	72
Answer Phone Calls	73
In-Call Screen Layout and Operations	76
Place a Call from Contacts	77
Call from Call Log	78
Voicemail Setup	79
Visual Voicemail	80
Review Visual Voicemail	81
Visual Voicemail Options	82
Configure Visual Voicemail Settings	84
Optional Calling Services	87
Wi-Fi Calling	87
Caller ID Blocking	88
Call Waiting	88
Conference Calling	89
Call Forwarding	90
Call Settings	91
Contacts	94
Add a Contact	94
View Contacts	96
Contacts Screen Layout	97
Edit a Contact	98
Delete a Contact	99

Favorites	100
Groups	101
Share a Contact	103
Profile Sharing	105
Import Contacts	107
Back Up Contacts	107
Contacts Settings	108
Messaging	110
Text and Multimedia Messaging	110
Send a Text Message	110
Send a Multimedia Message (MMS)	111
Save and Resume a Draft Message	113
New Messages Notification	113
Manage Message Conversations	114
Messages Settings	116
Gmail	117
Create and Send a Gmail Message	118
Check Received Gmail Messages	119
Use Gmail Labels	120
Archive Gmail Threads	121
Mute Gmail Threads	121
Delete Gmail Threads	122
Search Gmail Messages	122
Report Spam Gmail Messages	122
Add Another Google (Gmail) Account	122
Switching Between Gmail Accounts	123
Gmail Settings	123
Email	124
Set Up an Email Account	124
Add an Email Account	125
Add an Exchange ActiveSync Account	127
Create and Send an Email Message	128
Open Email Messages	129
Delete an Email Account	130
Manage Your Email Inbox	130
Exchange ActiveSync Email Features	131

Email Settings	133
Internet and Social Networking	136
Data Services General Information (4G LTE and 3G Networks)	136
4G LTE	136
Your User Name	137
Data Connection Status and Indicators	138
Browser	138
Use the Browser	139
Add a Bookmark	139
View Browser History	140
Open New Browser Tabs	141
Browser Settings	142
Chrome Browser	143
Facebook	144
Hangouts	144
Instagram	146
Messenger	146
Global Services	147
Activate Sprint Worldwide Service on Your Account	147
Your Phone's SIM Card for International GSM Roaming	147
Enable Global Roaming Mode	148
Set the Communications Method for Global Use	149
Select a Carrier	149
Make and Receive Worldwide Calls	149
Sprint International Voicemail Service	150
Set Up Your Voicemail Access Number for International Use	150
Access Your Voicemail Internationally	151
International Data Roaming	152
Access Email and Data Services Internationally	152
Contact Sprint for Assistance with International Service	153
Connectivity	155
Transfer Files between Your Phone and a Computer	155
Wi-Fi	156
Turn Wi-Fi On and Connect to a Wireless Network	157
Wi-Fi Settings	158
Disconnect Wi-Fi	158

Wi-Fi Direct	158
Hotspot	159
Bluetooth	160
Bluetooth Information	161
Enable the Bluetooth Feature	161
Pair Bluetooth Devices	162
Connect to a Paired Bluetooth Device	163
Send Information Using Bluetooth	164
Receive Information Using Bluetooth	166
Tethering	167
APPS AND ENTERTAINMENT	168
Camera and Video	169
Camera Overview	169
Take Pictures and Record Videos	170
Take a Picture	171
Record Videos	171
Shooting Mode	172
View Pictures and Videos Using Gallery	173
Camera Settings	175
Switch Cameras	175
Set Camera Functions	175
Live Broadcast	177
Productivity	180
1Weather	180
Calculator	180
Calendar	181
Add an Event to the Calendar	181
View Calendar Events	182
Sync Calendars	183
Synchronize an Exchange ActiveSync Calendar	183
Calendar Settings	184
Caller ID	184
Clock	185
Set Alarms	185
Additional Clock Features	186
Drive	187

Google Maps	187
Google Search	188
Lookout	189
My Files	189
Photos	190
S Voice	190
S Voice Settings	191
Samsung Gear	191
Samsung Notes	191
Samsung Pay	193
Sprint Family Locator	194
Tech Expert	194
Uber	195
Entertainment and Activities	196
Amazon Apps	196
App Spotlight	196
Galaxy Apps	197
Google Play Music App	197
Play Music with Google Play	197
Google Play Music Screen Layout	198
Create Playlists in Google Play Music	199
Live Soccer & TV	200
NextRadio	200
PEN.UP	200
S Health	200
Samsung+	202
Sprint Fun & Games	202
Sprint Music Plus	203
Sprint TV & Movies	204
Sprint Zone	204
YouTube	205
SETTINGS	207
Connections Settings	208
Basic Settings	208
Connection Settings Menu	210
Wi-Fi Settings Menu	210

Bluetooth Settings	212
Device Visibility	214
Data Usage Settings	215
Airplane Mode	216
NFC and Payment	216
Mobile Networks Settings	218
Location Settings	220
More Connection Settings	222
Nearby Device Scanning	223
Printing	224
Virtual Private Networks (VPN)	225
Wi-Fi Calling Settings	229
Hotspot and Tethering Settings	230
Hotspot Settings	230
Tethering Settings	232
Device Settings	234
Sounds Settings	234
Sound Mode	235
Vibrate While Ringing	236
Volume	237
Vibration Intensity	238
Ringtones and Sounds	238
Vibration Pattern	240
Notification Sounds	240
Do Not Disturb	241
System Sounds	243
Key-tap Feedback	244
Sound Quality and Effects	245
Notifications Settings	246
Display Settings	247
Brightness	248
Blue Light Filter	249
Font Size and Style	250
Edge Screen Settings	250
Content Scaling	256
Easy Mode	257

Icon Frames	258
Screen Timeout	259
Always On Display	259
Night Clock	260
Screen Mode	261
LED Indicator	262
Keep Screen Turned Off	262
Screen Saver	263
Advanced Features Settings	264
S Pen Settings	264
Smart Stay	265
Manage Game Features	265
One-Handed Operation	266
Other Advanced Features	267
Applications Settings	268
Applications Overview	269
Default Applications	271
App Permission Settings	272
Personal Settings	273
Wallpapers and Themes Settings	273
Wallpaper Settings	273
Themes	273
Icons	274
Lock Screen and Security Settings	275
Screen Lock	276
Iris Lock Settings	279
Disable the Screen Lock	280
Unknown Sources	280
Secure Folder	280
Secure Startup	280
Encrypt SD Card	281
Other Security Settings	281
Cloud and Accounts Settings	282
Samsung Cloud	283
Accounts	284
Backup and Reset	285

Samsung Account Backup Settings	287
Google Account Backup Settings	288
Auto Restart	289
Reset Settings	289
Reset Network Settings	290
Factory Data Reset	291
Smart Switch Settings	292
Google Settings	292
Accessibility Settings	293
Vision Accessibility Settings	294
Hearing Accessibility Settings	296
Dexterity and Interaction Settings	296
Configure Other Accessibility Settings	297
System Settings	299
General Management Settings	299
Language and Input Settings	299
Date and Time Settings	301
Device Maintenance Settings	302
Optimize Now	302
Battery Settings	303
Storage Settings	304
microSD Card Settings	305
RAM	310
System Update	310
Help Menu	311
About Device	312
GETTING HELP	314
For Assistance	315
Troubleshooting	315
Sprint Account Information and Help	316
Sprint Account Passwords	316
Manage Your Account	317
Sprint Support Services	317
Copyright Information	318
Intellectual Property	318
Open Source Software	318

Disclaimer of Warranties; Exclusion of Liability	319
Samsung Electronics America (SEA), Inc.	319
Do you have questions about your Samsung Mobile Device?	320
Legal Information	320
INDEX	321

Getting Started

The topics in this section will introduce you to your phone, help you get set up with service, provide an overview of the phone screen, and get you started with basic phone operations.

Introduction

The following topics describe the basics of using this guide and your new phone.

About the User Guide

Thank you for purchasing your new Samsung Galaxy Note 7. The following topics explain how best to use this guide to get the most out of your phone.

Before Using Your Phone

Read the Get Started guide and Important Information booklet that were packaged with your phone thoroughly for proper usage.

Accessible services may be limited by subscription contract conditions.

Descriptions in the User Guide

Note that most descriptions in this guide are based on your phone's setup at the time of purchase. Unless otherwise noted, instructions begin from the phone's home screen, which is displayed by pressing **Home** . Some operation descriptions may be simplified.

Screenshots and Key Labels

Screenshots and other illustrations in this user guide may appear differently on your phone. Key labels in the user guide are simplified for description purposes and differ from your phone's display.

Other Notations

In the user guide, the phone may be referred to either as “phone,” “device,” or “handset.” A microSD™, microSDHC™, or microSDXC™ card is referred to as an “SD card” or a “memory card.”

Access Instructions on Phone



These topics will help you find help on your new phone and will introduce the basics of using your phone's touchscreen if you are a new user.

Access Help

Use the phone's Help menu to learn about your phone.

1. Press **Home**  to display the home screen.



2. From home, tap **Apps**  > **Settings**  > **Help** .
3. Tap a topic to view its contents, or tap **Search** to search for a topic.

Get Support from Sprint Zone

In addition to your phone's built-in Help menu, you can also access support for your phone and service through the preloaded Sprint Zone app.

1. From home, tap **Apps**  > **Sprint Zone** .

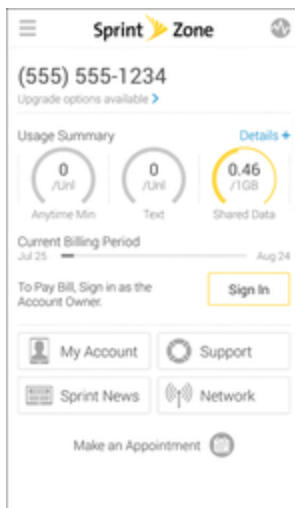

2. From the Sprint Zone main page, tap **Support**.

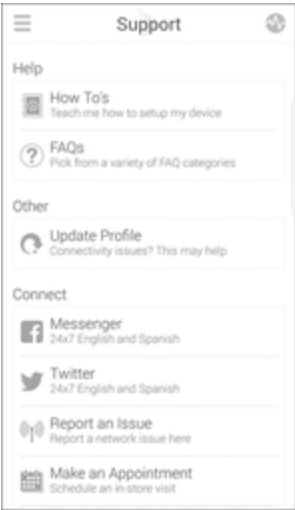

3. Tap a topic to view its contents.

Set Up Your Phone

The following topics give you all the information you need to set up your Samsung phone and wireless service the first time.

Parts and Functions

These topics illustrate your phone's primary parts and key functions.

Note: Your phone's screens and apps layouts are subject to change. This user guide uses sample images only.



Phone Layout

The following illustration outlines your phone's primary external features and keys.

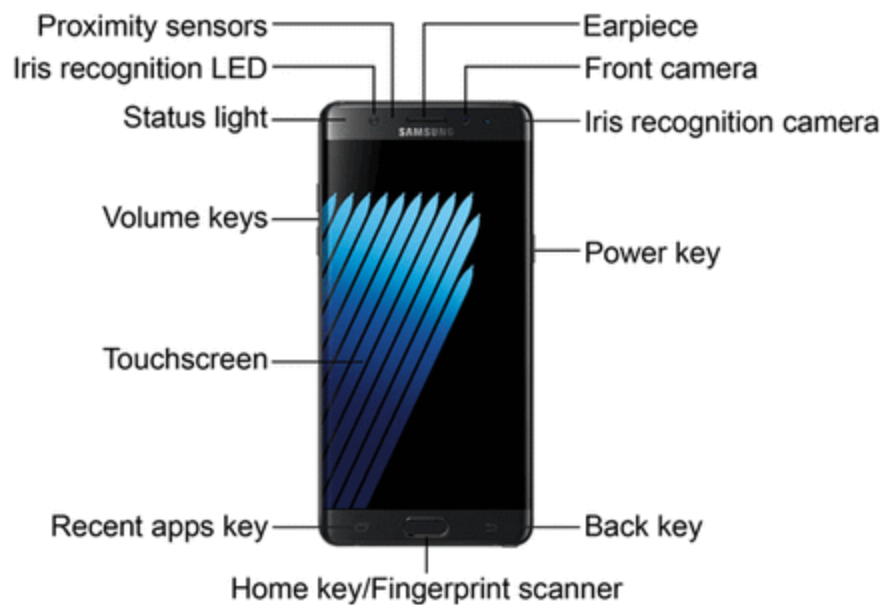
Front View



Part	Description
Earpiece	Listen to calls and automated prompts when using the phone.
Front camera	Takes pictures and records videos while facing the screen, and allows you to video conference.
Iris recognition camera	Scans your iris as a security feature.
Power key	Turn the phone or screen on or off, or switch your phone to Emergency mode.

Part	Description
Back key 	Return you to the previous screen, or close a dialog box, options menu, the notification panel, or keyboard.
Home key/fingerprint sensor 	Return you to the home screen. Press and hold to open Google™ Search/Google Now™. Use to register fingerprints for security.
Recent apps key 	Access recently used apps.
Touchscreen	Display information needed to operate your phone, such as the call status, the Contacts list, and the date and time. Also provides one-tap access to all of your features and applications.
Volume keys	Adjust the ringtone or media volume or adjust the voice volume during a call.
Status light	Display a light when the battery is charging or fully charged, when a notification arrives, or when recording voice
Iris recognition LED	Illuminate your eyes for the Iris scanner.
Proximity sensors	Detect the presence of objects near the device.

Back View



Part	Description
SIM card/Memory card tray	Location of the SIM card and memory card (not included).
Flash	Help illuminate subjects in low-light environments when the camera is focusing and capturing a picture or video.

Part	Description
Heart rate monitor	Measure your heart rate using your fingertip when using the S Health™ app. For more information, see S Health .
Headset jack	Plug in a headset for convenient, hands-free conversations.
USB charger/accessory port	Connect the phone to the charger using a USB cable.
Microphone	Transmit your voice for phone calls or record your voice or ambient sounds for voice recordings and videos.
S Pen	Stores the S Pen™.
Rear camera	Take pictures and videos.
Speaker	Play ringtones and sounds. The speaker also lets you hear the caller's voice in speakerphone mode.

Caution: Inserting an accessory into the incorrect jack may damage the phone.

Maintaining Water and Dust Resistance

This device is rated IP68 using the Ingress Protection rating system.

Your device has been tested in a controlled environment and shown to be water and dust resistant in certain circumstances (meets requirements of classification IP68 as described by the international standard IEC 60529 - Degrees of Protection provided by Enclosures [IP Code]; test conditions: 15-35°C, 86-106 kPa, 5.0 feet, for 30 minutes). Despite this classification, your device is not impervious to water damage in any situation. It is important that all compartments are closed tightly.

Note: If any liquid is found to have entered your device components or an internally sealed system, this condition will void your device warranty.

Follow these tips carefully to prevent damage to the device.

- Any device which uses accessible compartments or ports that can be opened should have these sealed or closed tightly to prevent liquid from entering the system.
- Whenever your device gets wet, dry it thoroughly with a clean, soft cloth.
- Do not expose the device to salt water or ionized water, or to water over 5.0 feet deep for more than 30 minutes. If your device is exposed to fresh water, dry it thoroughly with a clean, soft cloth. If the device is exposed to any liquid other than fresh water, rinse the device with fresh water immediately and dry it thoroughly with a clean, soft cloth. Failure to rinse the device in fresh water and dry it as instructed may cause the device to suffer from operability or cosmetic issues.
- Do not expose the device to water at high pressure.
- If the device is dropped or receives an impact, the water and dust resistant features of the device may be damaged.

- The touchscreen and other features may not work properly if the device is used in water or in other liquids. [071516]

Charge the Battery

Your device is powered by a rechargeable, standard Li-Ion battery. A USB charger (charging head and USB cable) is included with the device, for charging the battery from any standard outlet.

The battery comes partially charged. You can use the device while charging.

Charge Using the AC Adapter (Charging Head)

It is recommended you fully charge the battery before using your device for the first time.

Note: For fastest charging times, use the Samsung Adaptive Fast Charger that came with your device. This charger provides faster charging only when connected to devices that support Adaptive Fast Charging.

Caution: Use only charging devices and batteries that are approved by Samsung. Samsung accessories are designed for your device to maximize battery life. Using other accessories may invalidate your warranty and may cause damage.

1. Insert the USB cable into the USB charger/Accessory port.



2. Connect the USB cable to the charging head, and then plug the charging head into a standard outlet.
3. Unplug the charging head from the outlet and remove the USB cable from the device when charging is complete.

Note: This device is also compatible with wireless charging devices approved by Samsung, which are sold separately.

Reverse Charging

The included USB connector allows you to charge another device through a USB cable. When connected, your battery is used to charge the other device, and  **Charging** appears on your device.

You can also use the USB connector for transferring contacts, photos, and other content from an old device. For more information, see [Smart Switch](#).

Micro-USB Connector

You can use the included Micro-USB connector to connect a Micro-USB cable (such as from your old device) to your new device for charging with the charging head, or for connecting to a computer.

Note: The Micro-USB connector does not support On-the-Go (OTG) devices such as memory sticks, external hard drives, or keyboard and mouse accessories.

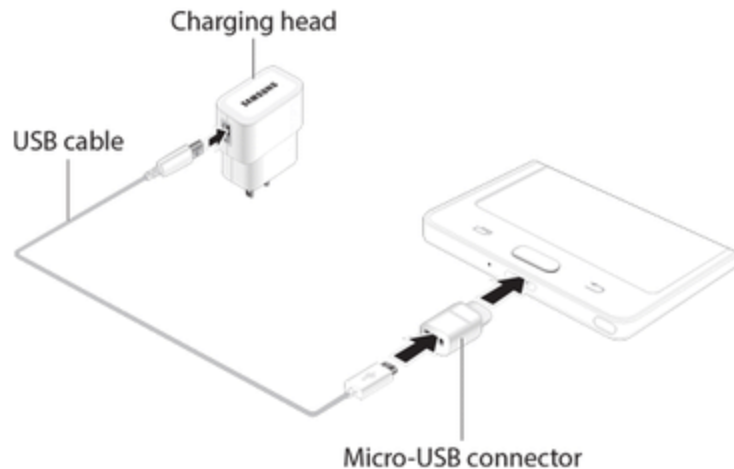

Charge Using a PC Connection

Before using a PC connection to charge your phone, ensure that the computer is turned on. Depending on the type of connection, your phone's battery may not charge.

1. Insert the small end of the USB cable into the USB charger/accessory port on the bottom of your phone.



2. Insert the large end of the USB cable into a USB port on your computer.
3. After charging, remove the USB cable from both the phone and the computer.

SIM Card

The SIM card is an IC card containing phone number and other customer information. Your phone's SIM card is preinstalled and should only be accessed if directed by a customer service representative.

Handling a SIM Card

Keep the following in mind when handling a SIM card:

- You are responsible for any damage caused by inserting the SIM card in another brand IC card reader, etc. Sprint is not responsible in such a case.
- Always keep the IC chip clean.
- Wipe clean with a dry, soft cloth.
- Avoid applying labels. May damage SIM card.
- See instructions included with SIM card for handling.
- The SIM card is the property of Sprint.
- The SIM card is replaceable (at cost) in case of loss/damage.
- Return the SIM card to Sprint when canceling subscription.
- Returned SIM cards are recycled for environmental purposes.
- Note that SIM card specifications and performance may change without notice.
- It is recommended that you keep a separate copy of information that is stored on SIM card. Sprint is not responsible for damages from stored information that is lost.
- Always follow emergency procedures to suspend service if your SIM card or phone (SIM card inserted) is lost or stolen. For details, contact Customer Service.
- Always power off the phone before inserting/removing the SIM card.

Insert SIM Card

Follow these instructions to insert a SIM card. Remember to power off your phone before inserting a SIM card.

Note: Your phone's SIM card is preinstalled. These instructions are for reference only.

Caution: Exercise care when using the removal tool to eject the internal SIM card/Memory card tray.

1. Insert the removal tool into the hole on the SIM card/Memory card tray, and push until the tray pops out.

2. Place the SIM card on the tray.



- Make sure that the card's gold contacts face down into the device and that the card is positioned as shown.

3. Slide the SIM card/Memory card tray back into the slot.

Important: To prevent water and dust from entering the device, remove any dust on the gasket and ensure that the SIM card tray is closed tightly.

Caution: If the SIM card is not inserted correctly, the device cannot detect it. Reorient the card and place it back into the slot if the SIM card is not detected.

SD Card

Your phone supports the use of an optional SD card (not included) to expand its storage capacity. Some cards may not operate properly with your phone.

SD Card Cautions

Data: Information stored on an SD card can become lost or changed accidentally or as a result of damage. It is recommended that you keep a separate copy of important data. Sprint is not responsible for damages from data that is lost or changed.

Reading/Writing Data: Never power off or remove the battery while reading or writing data.

Battery Level: A low battery charge may prevent reading/writing to an SD card.

Handling SD Card: Use/store SD cards away from the reach of infants. SD cards may cause choking if swallowed.

Insert an SD Card

Follow these steps to insert an optional SD card (not included). Make sure to power your phone off before inserting or removing an SD card.

Note: To improve performance and reliability with High-definition video recording and playback, it is recommended you use a memory card (SD card) that is both rated as at least a Class 10 and provides a high read speed.

Caution: Exercise care when using the removal tool to eject the internal SIM card/Memory card tray.





1. Insert the removal tool into the hole on the SIM card/Memory card tray, and push until the tray pops out.
2. Place the memory card on the tray with the gold contacts facing down.



3. Slide the SIM card/Memory card tray back into the slot.

Unmount an SD Card

Always unmount an SD card before removing it from your phone.

1. From home, tap **Apps**  > **Settings** .
2. Tap **Device maintenance**  > **Storage**.
3. Tap **More options**  > **Storage settings** > **SD card** > **Unmount**.

 The card is now unmounted.

Remove an SD Card

Follow these instructions to remove an SD card. Always power the phone off before inserting or removing an SD card.

Caution: Exercise care when using the removal tool to eject the internal SIM card/Memory card tray.

1. Insert the removal tool into the hole on the SIM card/Memory card tray, and push until the tray pops out.

2. Slide the tray out and remove the memory card.







3. Slide the SIM card/Memory card tray back into the slot.

Format an SD Card

When you insert an optional SD card for the first time, it is recommended that you format it.

Caution: Formatting an SD card permanently deletes all data on it.

1. From home, tap **Apps**  > **Settings** .
2. Tap **Device maintenance**  > **Storage**.
3. Tap **More options**  > **Storage settings** > **SD Card** > **Format**.
4. Tap **Format** to confirm.

❖ All data on the SD card is erased, and the card is formatted for use on your phone.

Turn Your Phone On and Off

The instructions below explain how to turn your phone on and off.

Turn Your Phone On

- Press and hold the **Power key**.



- ❖ Your phone will power on. Depending on the settings, you may see the lock screen.
 - See [Lock and Unlock Your Screen](#) and [Screen Lock](#) for information about using the screen lock.
 - The first time you turn the phone on, you will see the startup screens. See [Complete the Setup Screens](#) for details.
 - If your phone is not yet activated, see [Activate Your Phone](#) for more information.

Turn Your Phone Off

1. Press and hold the **Power key** to display the device options menu.
2. Tap **Power off** > **Power off** to turn the phone off.

- ❖ Your phone will power off.

Your screen remains blank while your phone is off (unless the battery is charging).

Use the Touchscreen

Your phone's touchscreen lets you control actions through a variety of touch gestures.

Tap

When you want to type using the keyboard, select items such as application and settings icons, or press buttons, simply tap or touch them with your finger.



Touch and Hold

To open the available options for an item (for example, a contact or link in a Web page), touch and hold the item.

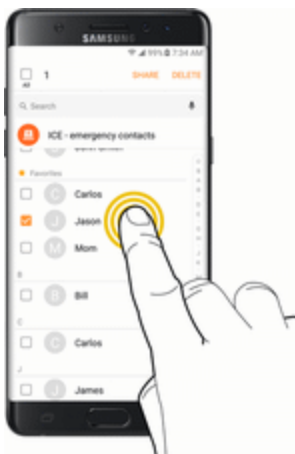

Swipe or Slide

To swipe or slide means to quickly drag your finger vertically or horizontally across the screen.



Drag

To drag, press and hold your finger with some pressure before you start to move your finger. While dragging, do not release your finger until you have reached the target position.



Flick

Flicking the screen is similar to swiping, except that you need to swipe your finger in light, quick strokes. This finger gesture is always in a vertical direction, such as when flicking the contacts or message list.



Rotate

For most screens, you can automatically change the screen orientation from portrait to landscape by turning the phone sideways. When entering text, you can turn the phone sideways to bring up a bigger keyboard. See [Samsung Keyboard](#) for more details.



Note: Auto rotate needs to be enabled for the screen orientation to automatically change. Pull down the status bar to display the notification panel, and then tap **Portrait** > **Auto rotate** > **Done** to enable the option.

Pinch and Spread

Pinch the screen using your thumb and forefinger to zoom out or spread the screen to zoom in when viewing a picture or a Web page. (Move fingers inward to zoom out and outward to zoom in.)



Activate Your Phone

Follow the instructions below to activate your phone if it has not already been activated. Depending on your account or how and where you purchased your phone, it may be ready to use or you may need to activate it on your Sprint account.

- If you purchased your phone at a Sprint Store, it is probably activated and ready to use.
- If you received your phone in the mail and it is for a new Sprint account or a new line of service, it is designed to activate automatically.
 - When you turn the phone on for the first time, you should see a **Hands Free Activation** screen, which may be followed by a **PRL Update** screen and a **Firmware Update** screen. Follow the prompts to continue.
- If you received your phone in the mail and you are activating a new phone for an existing number on your account (you are swapping phones), you can activate on your computer online or directly on your phone.
 - **Activate on your computer:**
 - Go to sprint.com/activate and complete the online instructions to activate your phone.
 - **Activate on your phone:**
 - Turn on your new phone. (Make sure the old one is turned off.) Your phone will automatically attempt Hands-Free Activation.

- Tap **Activate** to override auto-activation and start the manual activation wizard.
- Follow the prompts to complete the activation process.

To confirm activation, make a phone call. If your phone is still not activated, visit sprint.com/support for assistance. If you do not have access to the Internet, call Sprint Customer Service at **1-888-211-4727** from another phone.

Tip: Do not press the **Power key** while the phone is being activated. Pressing the **Power key** cancels the activation process.

Note: If you are having any difficulty with activation, visit sprint.com/support.

Complete the Setup Screens

The setup screens help you set up certain features and preferences on your phone. Once your phone has been turned on, you will see a Welcome message. You can then complete the setup process.

Note: You may be able to complete the setup screens before your phone has been activated on your account.

1. From the Welcome screen, select a language and tap **Start** to get started.
 - To skip any section, tap **Next** or **Skip**.

Note: On the Welcome screen, there may also be an **Accessibility** button. If you are visually impaired or hard of hearing, tap **Accessibility** to change the accessibility settings.

2. Follow the prompts to complete each section. For each topic, you will have the option to skip it and continue to the next screen.
 - **Wi-Fi** – If prompted, follow the prompts to sign in to an available Wi-Fi® network. For secured Wi-Fi networks, you will need to enter a password. See [Wi-Fi](#) for more details.
 - **Terms and Conditions** – Read any applicable End User License Agreements or Terms and Conditions for using your phone, and tap **Next > Agree** to continue.
 - **Got another device?** – If you have another Android™ phone, you can quickly transfer your setup to this phone.
 - **Google (Add your account)** – Tap **Enter your email** and complete the steps to sign in to your current Google Account, or tap **Or create a new account** to set up a new Google Account. Tap **Skip** to skip Google setup. The following options may apply depending on your selection:

Note: When you sign in to a Google Account on your device, Factory Reset Protection is turned on. Factory Reset Protection (FRP) prevents other people from using your device if it is reset to factory settings without your permission. See [Factory Reset Protection](#) for more information.

- **Enter your email** – Enter your Gmail™ address and password and tap **Accept** to agree to the terms of service and privacy policy and sign in to your current Google Account.
 - **Or create a new account** – Follow the instructions to sign up for a new Google Account. There will be screens to enter your first and last names, create an email address (Gmail), create a password, enter recovery information (including a backup email address and recovery question), an option to join Google+™, and an option to enable purchases from the Google Play™ store app. Tap **Next** between each screen.
 - **Set up payment info** – Select billing options for purchases made through Google Play. Select **Remind me later** to skip this step.
 - **Get your apps & data** – If you are using a Google Account you had set up on a previous Android device, you can choose to use that device's backup information to restore backed-up apps, data, system settings, Wi-Fi passwords, etc., from the previous device to your new phone. Tap **Set up as a new device** to skip this step.
- **Date & time** – Adjust the date and time, if necessary.
 - **Personalize your phone** – If applicable, enter your first and last name and tap **Next**. This information is used by the phone to personalize certain apps.
 - **Set up email** – Set up an email account.
 - **Protect your phone** – Set up a screen lock to prevent others from using the phone without your permission.
 - **Google services** – Select your Google location and service options and then tap **Next**.
 - **Samsung account** – Enter your email account and password to sign in to your current Samsung account, or tap **Create account** to set up a new Samsung account.
 - **Get your content**: Restore your content, such as images, contacts and more from Samsung Cloud, or by copying content from your old device using a USB cable.
3. Tap **Finish**. Your setup is now complete. Follow the prompts to learn about basic tap menu navigation, view tutorials, or just get started.
- ❖ Your phone is now set up for use. If you skipped any part of the setup, you can access additional options through the Apps screen or through Settings.

Note: You do not need to sign up for a Google Account to use your phone. However, to download apps from Google Play, you must link your phone to a Google Account.

Smart Switch

Use Smart Switch™ to transfer contacts, photos, and other content from your old device. You can also use the included USB connector to copy content quickly and easily from your old device, without

installing the Smart Switch app.

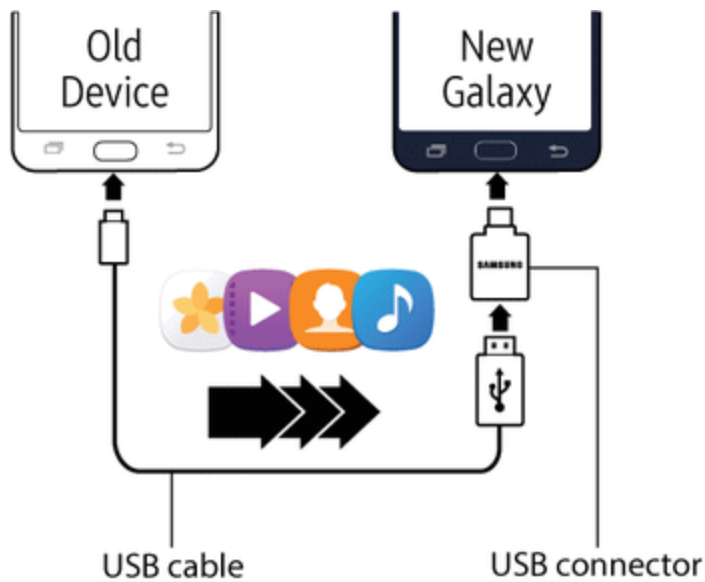

Note: The USB option must be set to Media device (MTP) on the other device. Transferring content with a USB cable may increase battery consumption. Make sure your battery is fully charged. The USB connector does not charge the battery.

1. Select Smart Switch during setup.

– or –

From a Home screen, tap **Apps**  > **Settings**  > **Cloud and accounts** > **Smart Switch**.

2. Follow the prompts and select the content to transfer.

Visit samsung.com/smartswitch for more information and to learn how to use the USB connector to transfer content faster.

Basic Operations



The following topics outline basic features and operations of your phone.

Basics

The following topics offer an overview of your phone's basic operations.

Home Screen and Applications (Apps) List

Most of your phone's operations originate from the home screen or the Apps list.

1. From any screen press the **Home** key  to display the home screen.
2. Tap **Apps**  to display the Apps list.

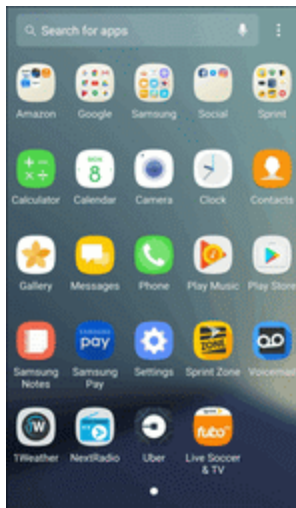

For information about using the home screen, see [Home Screen Basics](#).

Select Options and Navigate Screens

Tap icons, keys, and other items to open or activate the assigned function.

- Tap **Back**  to return to the previous screen.

Recent Applications

You can display a list of recently used applications using the Recent apps key.

- Tap **Recent apps**  to view a list of recently used applications.

Phone Settings Menu

You can customize your phone's settings and options through the Settings menu.

- From home, tap **Apps**  > **Settings** .

– or –

Pull down the status bar and tap **Settings** .

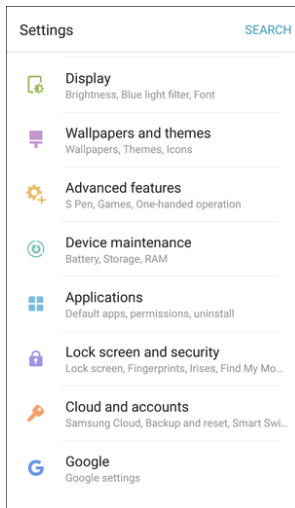

Portrait and Landscape Screen Orientation

The default orientation for your phone's screen is portrait (vertical), but many apps will change to landscape orientation (widescreen) when you rotate the phone sideways.





Note: Not all screens will adjust for landscape orientation.

Turn Screen Rotation On or Off

1. Pull down the status bar to display the quick settings menu.
2. Tap **Portrait** or **Auto rotate** and follow the prompts to turn the option on or off.

Capture Screenshots

You can use your phone's power and home keys to capture screenshots.

- Press and hold the **Power key** and **Home** key at the same time to capture a screenshot of the current screen.
- ❖ The current screenshot will be captured and stored in the Screenshots album in the phone's Gallery. From home, tap **Apps**  > **Gallery** .

Tip: Depending on your settings, you may also be able to capture screenshots by swiping your palm across the screen. See [Other Advanced Features](#) for details.

Edge Screen

The Edge screen provides a variety of useful tools for notifications, information feeds, and timekeeping.

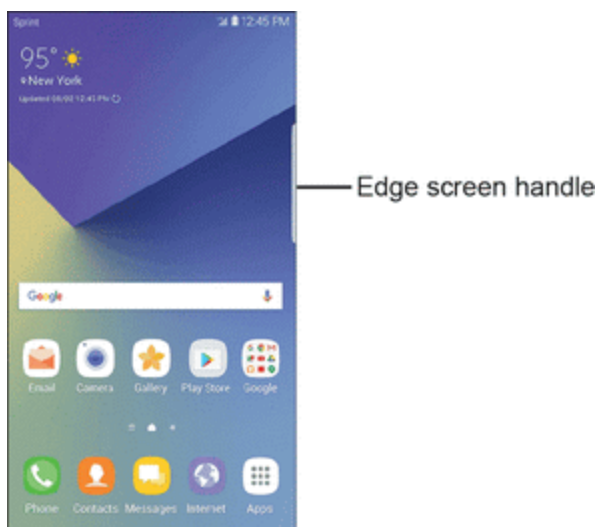

Edge Panels

Edge panels can be used to access apps, tasks, and contacts, as well as view news, sports, and other information on the Edge screen.

To view Edge panels:

- When the screen is turned on, swipe the Edge panel handle from the edge of the screen to the center. Keep swiping to view other panels.

To configure Edge panels:

- From any screen, open the Edge screen, and then tap **Settings** .

For more information, see [Edge Screen Settings](#).



Apps Edge

You can add up to ten apps in two columns to the Apps edge panel.

To view Apps edge:

- When the screen is turned on, swipe the Edge panel handle from the edge of the screen to the center. Keep swiping until the Apps edge panel is seen.

To configure Apps edge:

1. From any screen, open the Edge screen, and swipe until the Apps edge panel is displayed.
2. Tap **Add**  to add additional apps to the Apps edge.
 - To add an app to the Apps edge, find it on the left side of the screen and tap it to add it to an available space on a column on the right.
 - To change the order of the apps on the Edge panel, drag each app to the desired location.
 - To remove an app, tap **Remove** .
3. Tap **Back**  to save changes.



Tasks Edge

You can add shortcuts to common tasks performed with stock apps to the Tasks edge panel. Up to ten tasks in two columns can be added.

To view Tasks edge:

- When the screen is turned on, swipe the Edge panel handle from the edge of the screen to the center. Keep swiping until the Tasks edge panel is displayed.

To configure Tasks edge:

1. From any screen, open the Edge screen, swipe until the Tasks edge panel is displayed.
2. Tap **Add**  to add additional tasks to the Tasks edge.
 - To add a shortcut to the Tasks edge, find it on the left side of the screen and drag it on to an available space on a column on the right.
 - To change the order of the tasks on the Edge panel, drag each task to the desired location.
 - To remove a task, tap **Remove** .
 - To change the Tasks edge panel from one column to two, tap **Add column**.
3. Tap **Back**  to save changes.





People Edge

People edge allows you to set the Edge screen to light up with distinct colors when you receive notifications about contacts in your My people list. You can also use this panel to quickly communicate with contacts on your My people list.

To view People edge:

- When the screen is turned on, swipe the Edge panel handle from the edge of the screen to the center. Keep swiping until the People edge panel is seen.

To configure People edge:

1. From any screen, open the Edge screen, swipe until the People edge panel is displayed.
 - Tap **Add**  to add additional contacts to the People edge.
 - To remove a contact, touch and hold the contact, and then drag it to  **Remove**.
 - To change the order of the contacts on the Edge panel, drag each contact to the desired location.
2. Tap **OnCircle**  to communicate with your friends using images, stickers, and other fun messages.
3. Tap **Back**  to save changes.

Note: When OnCircle is enabled, you can access OnCircle contacts from the People edge panel by tapping **OnCircle** .

Edge Feeds

Edge feeds display select information and notifications on the Edge screen when the screen is turned off.

To view Edge feeds:

- When the screen is turned off, quickly swipe your finger along the Edge screen in one direction, and then back in the opposite direction.

For more information, see [Edge Screen Settings](#).

Edge Lighting

You can set the Edge screen to light up when you receive calls or notifications while the device is turned over.

For more information, see [Edge Screen Settings](#).

S Pen

Use S Pen and your phone to create and collaborate. With S Pen, you can:

- Write directly into a Gmail message.
- Write directly on the calendar.
- Annotate documents (Word, Excel®, PPT, PDF).
- Quickly open Notes from any screen.



Removing S Pen from Your Phone

S Pen is stored in your phone to keep it protected and easy to locate.

- Push the S Pen in to release it, and then slide it from your phone using the notch on the end.



Caution: When you insert the S Pen into the slot, insert the S Pen's tip first. Failure to do so can cause the S Pen to become stuck. Forcefully detaching the S Pen from the slot may cause damage to the S Pen and your device.

Note: To maintain the water-resistant and dust-resistant features of your device, make sure that the S Pen slot and opening are both maintained free of dust and water, and the pen is securely inserted prior to any exposure.

S Pen Options

Configure S Pen settings, including options for gestures and sounds, and for tracking S Pen when it is not stored in your phone.

- To access S Pen Settings, tap **Apps**  > **Settings**  > **Advanced features**  > **S Pen**.

Note: For more information about S Pen settings, see [S Pen Settings](#).

Air View

Hover the S Pen over items on the screen to display more information:

- **Information preview:** Preview information, extend text, or enlarge pictures by hovering your pen over the screens.
- **Icon labels:** View the labels of icons by hovering your pen over them.
- **List scrolling:** Scroll up or down lists by holding the pen over the top or bottom edge of the screen.
- **Link preview:** Hover your pen over a link to preview the linked content.
- **Air menu:** Hover your pen over the action button to attach or insert content, attach contacts, or add recipients to a message.

Note: The preview function is only available when the S Pen's pointer is a solid color.

Configure Air View



Enable Air view features, and learn about using them.

- From home, tap **Apps**  > **Settings**  > **Advanced features**  > **S Pen** > **Air view**.

Direct Pen Input

When filling out a form field in an app (like Name or Number in Contacts), you can open a Handwriting window to allow you to write an entry with the S Pen rather than type.

To use the Handwriting window:

1. When filling out a form field, hover the S Pen over the field until the Handwriting  icon appears.
2. Tap **Handwriting** . The Handwriting window appears.

3. Use the space provided in the window to write an entry by hand using the S Pen. While writing, your entries are converted into text.
 - To edit the converted text, use the Space, Delete, and Enter icons. To change the position of the cursor, drag the pointer below the cursor to the desired position for editing.
 - In Messages, tap **Drawing mode** to draw an image and attach it to your message.
4. When finished, tap **Done**.

Screen Off Memo

You can write quick memos without turning your device on.

Note: The screen off memo setting must be enabled. For more information, see [S Pen Settings](#).

To create a screen off memo:

1. Detach the S Pen while the screen is off.
2. Write on the screen.
 - Tap **Save** to save your memo to the Note app.
 - Tap **Delete** to discard the memo.

Replace the S Pen Tip

You can replace the tip of the S Pen when needed. Additional S Pen tips are included with the phone.

To replace the tip:

1. Use tweezers to pull out the S Pen tip.

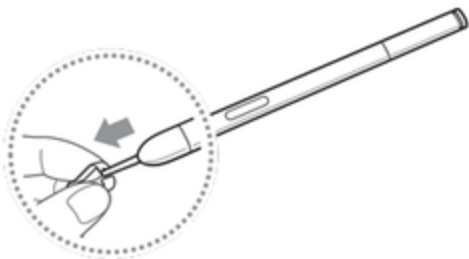

2. Insert the new pen tip on the top of the S Pen and press until it clicks in place.

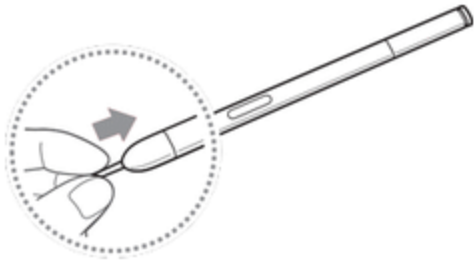

Air Command

Air command allows you to quickly activate frequently-used applications or perform actions.

- To launch the Air command menu, remove the S Pen from the S Pen slot, hold the S Pen near the screen so that the pointer appears, and then press the S Pen button once.

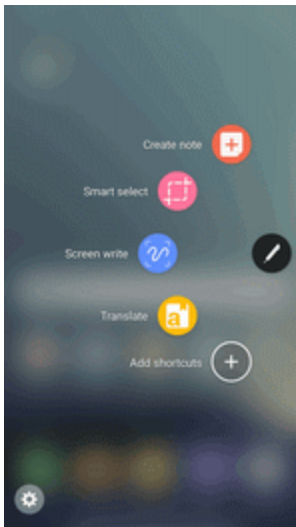

- **Create note:** Launch a new note in the Samsung Notes app.
- **Smart select:** Draw around an area of the screen to collect it in the Gallery app.
- **Screen write:** Capture screenshots and write or draw on them.
- **Translate:** Hover the S Pen over a word to see it translated into another language and listen to its pronunciation.
- **Add shortcuts:** Add up to three apps and functions to the Air command menu.
- **Settings:** Customize your Air command by adding apps and functions, and changing how it appears.

Create Note

Use Air command to launch a new note directly in the Samsung Notes app. For more information, see [Samsung Notes](#).

1. Remove S Pen from the slot, hold the S Pen near the screen so that the point appears, and press the S Pen button once.
2. Tap **Create note** .

Screen Off Memo



You can write quick memos without turning your device on.

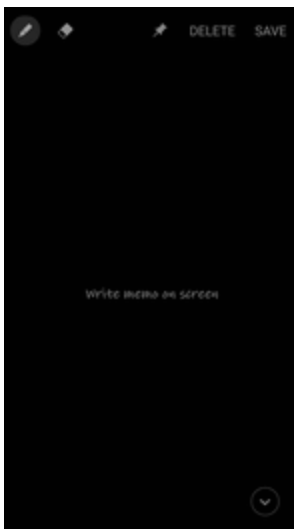

Note: The screen off memo setting must be enabled. For more information, see [S Pen Settings](#).

To create a screen off memo:

1. Detach the S Pen while the screen is off.
2. Write on the screen.



- Tap **Save** to save your memo to the Notes app.
- Tap **Delete** to discard the note.
- Tap **Pin**  to display the current memo when the screen is off.
- Tap **Pen**  to use the stylus to write on the screen.
- Tap **Erase**  to erase part or all of your writing.

- Tap **Create/Next**  to create a new memo or to go to the next memo.
- Tap **Previous**  to go to the next memo.

Smart Select

The Smart select feature provides a capture tool to select content on a screen. You can then add it to your Gallery app or share it with your contacts.

To launch the Smart select tool:

1. Remove the S Pen from the S Pen slot, hold the S Pen near the screen so that the pointer appears, and press the S Pen button once.

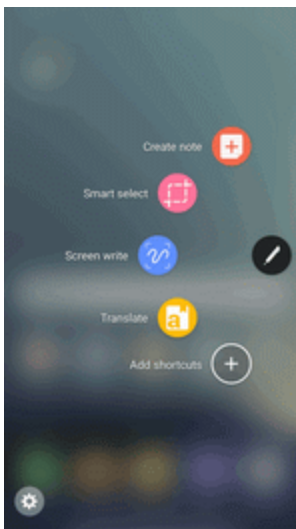

2. Tap **Smart select** .
 - Tap the shape you want to use: Rectangle, Lasso, or Oval.

- Draw around the content you want to select.

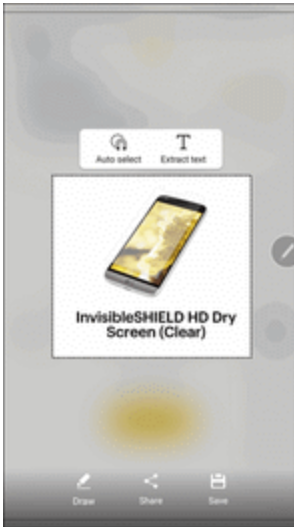

- The selected clip is centered on the screen.
 - Tap a selection shape to start over and select new content.
 - Tap  **Auto select** to automatically refine the selection based on the image. You can manually add or subtract from the selection, as well as rotate the selection left or right.

3. Tap an option at the bottom of the window:

- **Draw:** Draw or write on the screen using the S Pen.
- **Share:** Choose a sharing method to share your content.
- **Save:** Save the content to the Gallery app.

Screen Write

Screen write allows you to capture a screen shot and then write notes on the screen shot.

To use Screen write:

1. Remove the S Pen from the S Pen slot, hold the S Pen near the screen so that the pointer appears, and press the S Pen button once.

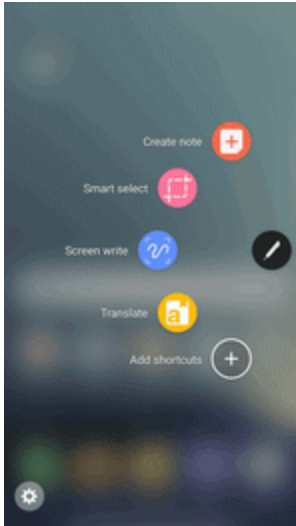

2. Tap **Screen write** . The current screen is captured, and a pen tool appears.

The following editing tools are provided:

- **Pen:** Write or draw on the screen shot. Press the Draw icon a second time to change the pen tip, size, color, and to save presets.
 - **Eraser:** Erase the writing or drawings on the screen shot. Tap the **Eraser** icon a second time to change the size of the eraser area and to see the **Clear all** option.
 - **Undo:** Undo the last action.
 - **Redo:** Redo the last action.
3. When you are finished writing, tap an option:
 - **Crop:** Crop the image.
 - **Share:** Share the image using messaging, Bluetooth[®], email, and more.
 - **Save:** Save the content to the Gallery app.



Translate

Translate words by hovering over them with the S Pen.

To use Translate:

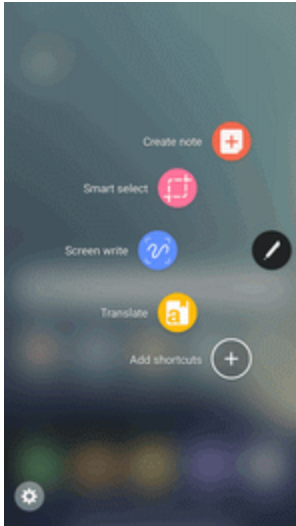
1. Remove the S Pen from the S Pen slot, hold the S Pen near the screen so that the pointer appears, and press the S Pen button once.



2. Tap **Translate** .
3. Tap the Source and Target languages to change them to the desired languages.
4. Hover the S Pen over a word.
 - Tap **Sound**  to hear the word pronounced in the Source language.
5. Tap **Close**  to close Translate.

Add or Remove Air Command Shortcuts

You can add or remove shortcuts to apps and functions to the Air command menu.

Add Air Command Shortcuts

1. Remove the S Pen from the S Pen slot, hold the S Pen near the screen so that the pointer appears, and press the S Pen button once.

2. Tap **Add shortcuts** .

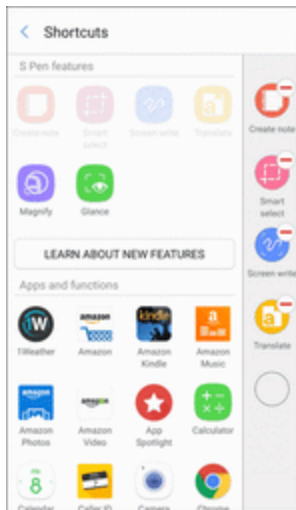

3. Swipe across the screens, and tap the apps or functions you would like to add to the Air command menu.
4. Tap **Back** to save your selection.

Remove Air Command Shortcuts

You can remove any Air command app shortcuts you have added.

1. Remove the S Pen from the S Pen slot, hold the S Pen near the screen so that the pointer appears, and press the S Pen button once.
2. Tap **Settings**  > **Shortcuts**.



3. Tap **Remove**  next to any shortcuts you want to remove.

- To add a new shortcut, tap it from the app list.

4. Tap **Back**  to save your settings.

Air Command Settings

Configure the Air command feature.

1. Remove the S Pen from the S Pen slot, hold the S Pen near the screen so that the pointer appears, and press the S Pen button once.
2. Tap **Settings** .

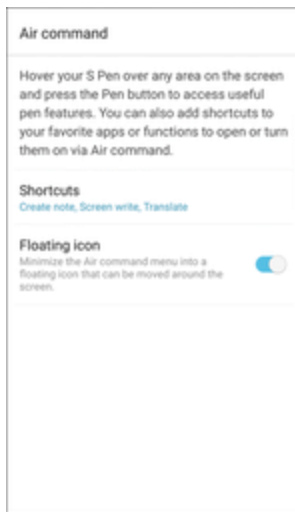

For more information, see [S Pen Settings](#).

Applications

The following topics describe how to access the applications (apps) list and launch apps on your phone.

Launch Applications

All installed apps can be accessed and launched from the Apps list.

1. From home, tap **Apps** .

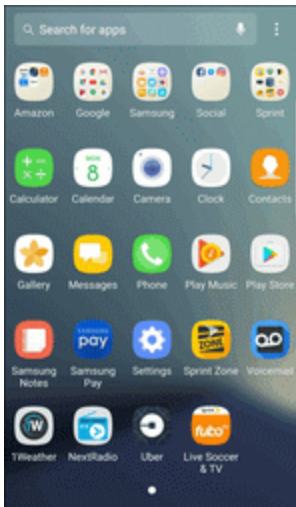







❖ The Apps list opens.

2. Tap an app icon to launch the corresponding application.















❖ The application opens.

















Apps List

The Apps list expands to include any apps you download and install on your phone. The following table outlines the primary apps that have been preinstalled on your phone.

App	Function/Service
 1Weather	Receive real-time local weather information at any location in the world. Access 7-day and hourly weather forecasts for your area. Located in the Sprint folder in the Apps list.
 Amazon (Amazon Shopping)	Shop at amazon.com™ from your device. Located in the Amazon™ folder in the Apps list.
 Amazon Kindle	Download books for reading right on your device. You must have an account with Amazon to use the Kindle™ application. Located in the Amazon folder in the Apps list.
 Amazon Music	Purchase, download, and play music from Amazon. Located in the Amazon folder in the Apps list.
 Amazon Photos	Store your photos on Amazon's cloud server. Located in the Amazon folder in the Apps list.
 Amazon Video	Watch Amazon Prime™ movies and videos on your phone. Located in the Amazon folder in the Apps list.
 Android Pay	Pay with your Android phone at over one million store locations across the US and within mobile apps. Visit android.com/pay to learn more about Android Pay™.



App	Function/Service
 App Spotlight	Discover new apps from the Google Play store. Located in the Sprint folder in the Apps list.
 Calculator	Perform basic and advanced mathematical calculations.
 Calendar	Use Calendar to create and manage events, meetings, and appointments, organize your time, and be reminded of important events.
 Caller ID	See who is calling, even if the caller is not in your contact list.
 Camera	Take pictures and record videos using the front and rear cameras.
 Chrome	Browse the Internet and bring your open tabs, bookmarks and address bar data from your computer to your mobile device. Located in the Google folder in the Apps list.
 Clock	Set alarms, view time in time zones around the world, use a stopwatch, set a timer, and use your phone as a desk clock.
 Contacts	Store and manage contacts from a variety of sources, including contacts you enter and save directly in your phone as well as contacts synchronized with your Google Account, compatible email programs (including Exchange Server), and your Facebook™ friends.
 Drive	Open, view, rename, and share your Google Docs™ and files. Located in the Google folder in the Apps list.
 Email	Send and receive email from a variety of email service providers. Located in the Samsung folder in the Apps list.
 Facebook	Keep up with friends and family with the Facebook app. Share updates, photos, and videos, as well as text, chat, and play games.
 Galaxy Apps	Discover apps designed exclusively for your Galaxy device. Located in the Samsung folder in the Apps list.
 Gallery	View and edit pictures and watch videos that you have taken with your phone's camera or downloaded.
 Gmail	Send and receive email with Gmail, Google's Web-based email service. Located in the Google folder in the Apps list.
 Google	Search not only the Internet, but also the apps and contents of your device. Located in the Google folder in the Apps list.
 Hangouts	Meet friends and family online, share photos, host video calls, and send SMS and Hangouts messages. Located in the Google folder in the Apps list.

App	Function/Service
 Instagram	Capture and share photos and videos with your friends. Customize what you capture, and then share it on your feed or post it directly to your friends. Located in the Social folder in the Apps list.
 Internet	Browse the Internet using a full-featured browser. Located in the Samsung folder in the Apps list.
 Live Soccer & TV	Watch live TV and sports on the go with fuboTV. A subscription is required to use this service.
 Lookout	Configure and manage key security options, such as anti-virus and anti-malware technology, a lost and stolen device locator service, an application privacy adviser, and a backup service. Located in the Sprint folder in the Apps list.
 Maps	Find your current location and get directions and other location-based information. Located in the Google folder in the Apps list.
 Messages	Send and receive text and multimedia messages.
 Messenger	Reach out to your friends and family with Facebook Messenger™, which works just like texting. A data plan is required to use Messenger. Located in the Social folder in the Apps list.
 My Files	Manage your sounds, images, videos, Bluetooth files, Android files, and other data in one convenient location. Located in the Samsung folder in the Apps list.
 NextRadio	Listen to your favorite FM radio stations on the go with NextRadio®. Tune in to any FM frequency in your area and listen to the radio without the cost of streaming music.
 PEN.UP	PEN.UP is an online community app that brings together anyone that uses the S Pen to draw, sketch, scribble or paint.
 Phone	Make and receive phone calls.
 Photos	Automatically back up your photos and videos to your Google Account. Located in the Google folder in the Apps list.
 Play Movies & TV	Watch movies and TV shows purchased from Google Play. You can stream them instantly, or download them for viewing when you are not connected to the Internet. You can also view videos saved on your device. Located in the Google folder in the Apps list.
 Play Music	Play music and audio files on your device.
 Play Store	Find new apps, movies and TV shows, music, books, magazines, and games in the Google Play store.

App	Function/Service
 S Health	Manage your health with the S Health wellness application. Set fitness goals, check your progress, and keep track of your overall health. Located in the Samsung folder in the Apps list.
 S Voice	Use the S Voice™ voice recognition application to activate a wide variety of functions on your phone. Located in the Samsung folder in the Apps list.
 Samsung Gear	Connect your device to your Samsung Gear using this application. Located in the Samsung folder in the Apps list.
 Samsung Notes	Create, edit, and manage all the notes on your phone with the Samsung Notes app.
 Samsung Pay	Use your phone to pay at more places than any other mobile payment service out there, from the grocery store to the coffee shop to your favorite department store.
 Samsung+	Get live help, discover new features, and unlock promotions for your Samsung device. Located in the Samsung folder in the Apps list.
 Settings	Configure settings and options on your phone.
 Sprint Family Locator	Use Sprint Family Locator to locate any phone on your Sprint family plan instantly—from your mobile phone, tablet or computer. Located in the Sprint folder in the Apps list.
 Sprint Fun & Games	Download new apps and games from Sprint. Located in the Sprint folder in the Apps list. Located in the Sprint folder in the Apps list.
 Sprint Music Plus	Purchase, download, and play music, ringtones, and ringback tones for your phone. Located in the Sprint folder in the Apps list.
 Sprint TV & Movies	Use Sprint TV & Movies to watch live TV and access movies and other on demand entertainment on the go. Located in the Sprint folder in the Apps list.
 Sprint Worldwide	Access information about Sprint Worldwide international voice and data service.
 Sprint Zone	Access your Sprint account, get device information and help, find recommended apps, and more.
 Tech Expert	Get access to a US-based technical expert.
 Uber	Hire a private driver in more than 130 cities and 30 countries. Uber is an entirely new and modern way to travel.
 Voicemail	Use Visual Voicemail for a quick and easy way to access your voicemail. Now you can find exactly the message you are looking for without having to listen to every voicemail message first.
 YouTube	View and upload YouTube™ videos from your device. Located in the Google folder in the Apps list.

Phone Number

Follow the instructions below to display your phone's wireless phone number.

1. From home, tap **Apps**  > **Settings**  > **About device** .
2. Tap **Status** > **SIM card status**.

❖ You will see the number listed under My phone number.

Airplane Mode

Airplane mode turns off all functions that emit or receive signals, while leaving your phone on so you can use apps that do not require a signal or data.

To turn on airplane mode:

1. Pull down the status bar to display the notification panel.
2. Pull it down again to display additional Quick settings, and then tap **Airplane mode**  > **Turn on**.

❖ Your phone is now in airplane mode. You will see the airplane mode icon  in the status bar.

To turn off airplane mode:

1. Pull down the status bar to display the notification panel.
2. Pull it down again to display additional Quick settings, and then tap **Airplane mode** .

❖ Your phone's wireless connection features are now restored.

Enter Text

You can type on your phone using the touchscreen Samsung keyboard or Samsung voice input.

Note: Keyboard layouts and options may change depending on where you are using them. For example, if you are entering text to do a Web search, a search icon may be available instead of an enter key.

Samsung Keyboard

Use the touchscreen Samsung keyboard for entering text. The keyboard appears automatically when you tap a text entry field, and can be used in either portrait or landscape mode. You can also use the Google voice typing option to enter text using your voice.

The Samsung keyboard offers a traditional QWERTY keyboard setup for entering text by tapping keys (like on a computer), along with enhancements and options that allow you to enter text faster and more accurately, such as continuous key input, personalized usage dictionaries, and more.





Assign Samsung Keyboard for Text Entry

If you have multiple text input methods installed on your device, you can select the Samsung keyboard to be your default text input method from Settings, or you can choose it at any time while entering text.

Note: The Samsung keyboard is the default text input method on your phone. Additional keyboards and input methods are available for download from the Google Play store. See [Google Play Store](#).









From Settings:







- From home, tap **Apps**  > **Settings**  > **General management**  > **Language and input** > **Default keyboard**, and then choose **Samsung keyboard**.

While entering text:

1. While entering text, drag down from the top of the screen to open the notification panel.
2. Tap **Select keyboard**, and then choose **Samsung keyboard**.

Use Samsung Keyboard to Enter Text

- Tap keys to enter text. While entering text, use these options:
 - If you make a mistake, tap **Delete**  to delete incorrect characters. Touch and hold **Delete**  to delete a whole word or field.
 - Tap **Shift**  to change the case of the text (the arrow will turn blue). Tap **Shift**  twice to switch to all capitals (the key will turn blue).
 - Tap **Symbols**  to switch to a symbols keyboard. There are two symbol keyboards; to switch between them, tap **Symbols (1 of 2)**  or **Symbols (2 of 2)** .
 - Tap **Samsung voice input**  to switch to Samsung voice input to enter text by speaking. See [Samsung Voice Input](#).
 - Touch and hold **Options**  to open an options menu. Select from the following options.

-  **Samsung voice input** to switch to Samsung voice input.
 -  **Handwriting** to enter text using the S Pen.
 -  **Clipboard** to attach a screenshot or other item from the clipboard.
 -  **Emoticon** to display a list of emoticons.
 -  **Settings** to view the Samsung keyboard settings menu.
- If you have more than one language selected in Samsung Keyboard settings, you can swipe your finger over **Spacebar**  to switch between languages.

Configure Samsung Keyboard

- From home, tap **Apps**  > **Settings**  > **General management**  > **Language and input** > **Samsung keyboard**.

Samsung Voice Input

Use Samsung Voice Input Instead of typing, enter text by speaking.

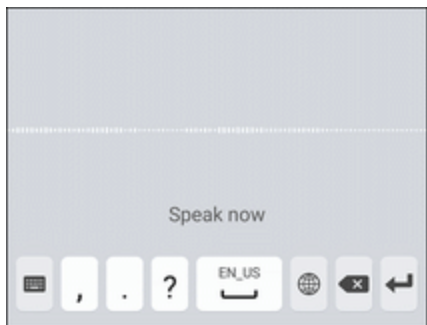



To enable Samsung voice input:

1. Tap **Samsung voice input**  on the Samsung keyboard.
 - You may need to touch and hold **Options** (left of the Space bar) to find it.
2. Speak your text.

Note: Tap **Language**  to download additional languages for use with Samsung voice input.







Configure Samsung Voice Input

To customize Samsung voice input:

1. From a Home screen, tap **Apps**  > **Settings**  > **General management**  > **Language and input**.
2. Tap **Samsung voice input** for options.

For more information, see [Language and Input Settings](#).

Tips for Editing Text

- Your phone gives you many options to make entering text easier, including copying, cutting, and pasting. Double-tap text to highlight it, and then select from the following options:
 -  **Select all**: Highlights all the text in the field.
 -  **Cut**: Removes the selected text and saves it to the clipboard.
 -  **Copy**: Copies the selected text to the clipboard.
 -  **Paste**: Insert the last copied or cut text into the current field.
 -  **Sharing**: Send the text with others using a variety of sharing methods.
 -  **Clipboard**: Display the clipboard to choose previously cut or copied text.
 -  **Dictionary**: Access your personal dictionary.

Google Account

You will need a Google Account to access several phone features such as Gmail, Google Maps™, Hangouts, and the Google Play applications. Before you are able to access Google applications, you must enter your account information. These applications sync between your phone and your online Google Account.

Google Account Cautions

Be sure not to forget your Google Account ID or password.

Create a Google Account

If you do not already have a Google Account, you can create one online or using your phone.



Note: You can also create and sign into your Google/Gmail account through your phone's Setup application.

Note: Although you need a Gmail account to use certain features of your phone, such as Google Play, you do not need to use Gmail as the default account for your phone.

Create a Google Account Online

1. From a computer, launch a Web browser and navigate to google.com.
2. On the main page, click **Sign-in > Create account**.
3. Follow the prompts to create your free account.
4. Look for an email from Google in the email box you provided, and respond to the email to confirm and activate your new account.

Create a Google Account Using Your Phone

1. From home, tap **Apps**  > **Settings**  > **Cloud and accounts**  > **Accounts > Add account**.
2. Tap **Google**, and then tap **Or create a new account**.

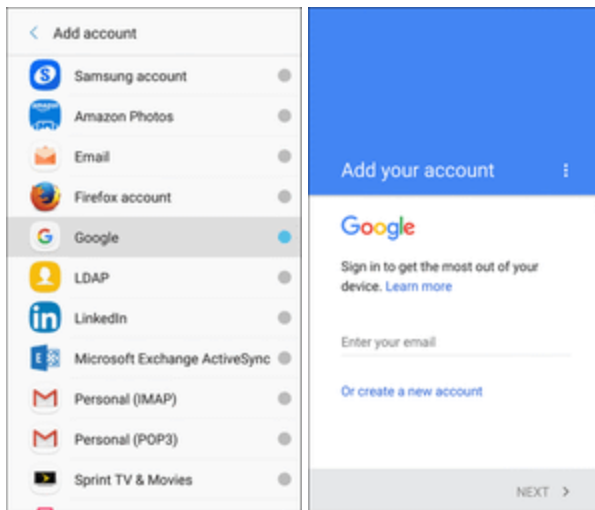

3. Follow the prompts to set up your account. Tap **Next** to proceed between steps, which may include:
 - Enter your **First name** and **Last name**.
 - Enter a desired **Username**.
 - Enter and reenter a password.
 - Create a security question and answer, enter a secondary email address to help you recover your password if you ever lose it.
 - On the Finish account screen, select your Web history and additional Google Play options.
 - Enter the letters from the Authenticating screen.

- After your phone connects with the Google servers, select the items you would like to sync with your phone and then tap **Sync now**.



4. Tap **Finish setup**.

- ❖ You are signed in to your Google Account, and your phone will synchronize the selected items.

Note: When setting up a new Google Account, either on your phone or online, you will be prompted to add a secondary email address. Enter a second Gmail address or any other email address from which you currently send and receive email. This address is used to authenticate your account should you ever encounter problems or forget your password. It is strongly encouraged for Android users so you can regain access to Google services and purchases on your phone.

Sign In to Your Google Account

If you have a Google Account but have not yet signed in with your phone, follow these instructions to sign in to your Google Account.

1. From home, tap **Apps**  > **Settings**  > **Cloud and accounts**  > **Accounts** > **Add account**.
2. Tap **Google**, and then tap **Enter your email**.

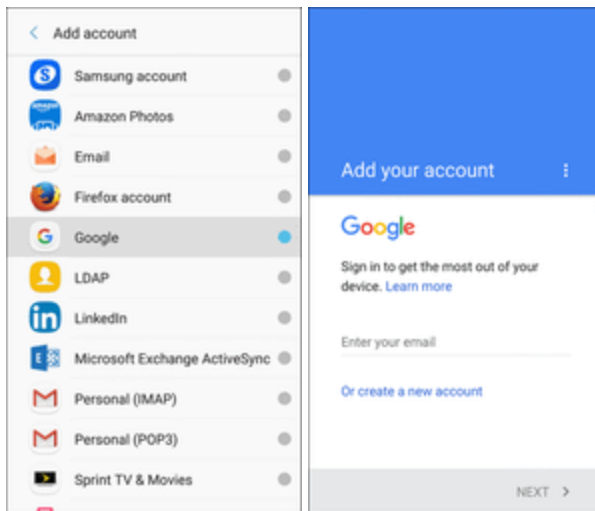

3. Enter your Gmail address and password, and then tap **Next**.
4. Complete any additional screens if prompted.

- ❖ You are signed in to your Google Account.

Factory Reset Protection

When you sign in to a Google Account on your device, Factory Reset Protection is automatically turned on. Factory Reset Protection (FRP) prevents other people from using your device if it is reset

to factory settings without your permission. For example, if your device is lost or stolen and a factory data reset is performed, only someone with your Google Account username and password can use the device.

You will not be able to access the device after a factory data reset if you do not have your Google Account username and password. For more information, see [Factory Data Reset](#).



Caution: You should remove your Google Account before shipping your device to Samsung or any other service provider for service and before resetting the device to factory settings.

Enable Factory Reset Protection

Adding a Google Account to your device automatically turns on the Factory Reset Protection (FRP) security feature. For more information, see [Sign In to Your Google Account](#).

Disable Factory Reset Protection

To disable FRP, remove all Google Accounts from the device.

1. From home, tap **Apps**  > **Settings** .
2. Tap **Cloud and accounts** > **Accounts** > **Google**.
3. Select a Google Account, and then tap **More options**  > **Remove account**.
4. Repeat until all configured Google Accounts have been removed from the device.

Google Play Store

Google Play is the place to go to find new Android apps, books, movies, and music for your phone. Choose from a wide variety of free and paid content ranging from productivity apps and games to bestselling books and blockbuster movies and music. When you find what you want, you can easily download and install it on your phone.

To access the Google Play store app, you must first connect to the Internet using your phone's Wi-Fi or mobile data connection and sign in to your Google Account. See [Browser](#) and [Sign In to Your Google Account](#) for details.

Installing Applications



Many different kinds of applications can be installed on your phone from Google Play (provided by Google Inc.). Sprint is not responsible in any way for user-installed applications (quality, reliability, legality, fitness for a purpose, credibility, accuracy, etc.) or resulting malfunctions (viruses, etc.).

Important: Our policies often do not apply to third-party applications. Third-party applications may access your personal information or require us to disclose your customer information to the third-party application provider. To find out how a third-party application will collect, access, use, or

disclose your personal information, check the application provider's policies, which can usually be found on their website. If you aren't comfortable with the third-party application's policies, do not use the application.

Find and Install an App

When you install apps from Google Play app and use them on your phone, they may require access to your personal information (such as your location, contact data, and more) or access to certain functions or settings of your phone. Download and install only apps that you trust.

1. From home, tap **Apps**  > **Play Store** .
2. When you open the Google Play store app for the first time, the Terms of Service window will appear. Tap **Accept** to continue.
3. Browse through the categories, find an item you are interested in, and tap the name.
 - Search for an app. Tap the **Google Play** search field, enter the name or type of app you are looking for, and then tap  on the keyboard.
4. Tap an app to read a description about the app and user reviews.
5. Tap **Install** (for free applications) or the **price** (for paid applications).

Note: If you have not already done so, you will need to set up a payment method to purchase paid apps from Google Play.

6. The subsequent screen notifies you whether the app will require access to your personal information or access to certain functions or settings of your phone. If you agree to the conditions, tap **Accept** (for free apps) or **Accept** and then **Buy** (for paid apps) to begin downloading and installing the app.
 - If you have not already set up a payment method, tap **Continue** and then follow the prompts to arrange payment and complete the purchase.
-  The selected app is downloaded and installed on your phone.

Warning: Read the notification carefully! Be especially cautious with applications that have access to many functions or a significant amount of your data. Once you tap **Ok** on this screen, you are responsible for the results of using this item on your phone.



Purchasing Applications

Purchase apps at your own risk. Sprint is not responsible for any harm to you or third parties resulting from the use of purchased applications.

Request a Refund for a Paid App

If you are not satisfied with an app, you can ask for a refund within 15 minutes of the purchase. Your credit card is not charged and the app is uninstalled from your phone.



If you change your mind, you can install the app again, but you cannot request a refund a second time.

1. From home, tap **Apps**  > **Play Store** .
2. Tap **Menu**  > **My apps & games**.
3. Tap the app to uninstall for a refund. The details screen for the app opens.
4. Tap **Refund**, and then tap **Yes** to confirm. Your app is uninstalled and the charge is cancelled.

Update an App

Depending on your settings, many apps will update automatically, or you can update apps directly from the Play store app.



Update an App Directly

1. From home, tap **Apps**  > **Play Store** .
2. Tap **Menu**  > **My apps & games**.



3. Tap the app you want to update, and then tap **Update**.
 - ❖ The app update is downloaded and installed.

Set Automatic App Updates

1. From home, tap **Apps**  > **Play Store** .
2. Tap **Menu**  > **My apps & games**.



3. Tap the app you want to set for auto-update, and then tap **Menu**  > **Auto-update**.
 - ❖ The app is set to update automatically whenever an update becomes available.

Note: Automatic updates are unavailable for some apps.

Uninstall an App

You can uninstall any app that you have downloaded and installed from Google Play.

1. From home, tap **Apps**  > **Play Store** .

2. Tap **Menu**  > **My apps & games**.





3. On the Installed screen, tap the app you want to uninstall, and then tap **Uninstall** > **OK**.

❖ The app is uninstalled and removed from your phone.

Get Help with Google Play

The Google Play store app offers an online help option if you have questions or want to know more about the app.

1. From home, tap **Apps**  > **Play Store** .
2. Tap **Menu**  > **Help & Feedback**.

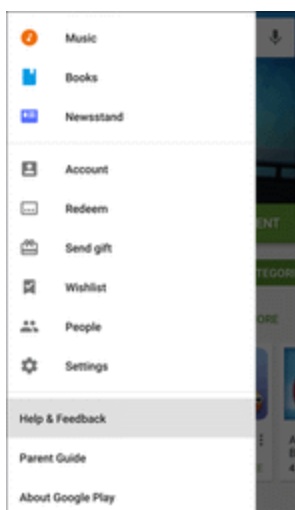

- ❖ The Web browser will take you to the Google Play Help Web page, where you will find comprehensive, categorized information about Google Play.

Lock and Unlock Your Screen

Your phone allows you to quickly turn the screen off when not in use and to turn it back on and unlock it when you need it.

Turn the Screen Off When Not in Use

- To quickly turn the screen off, press the **Power key**. Pressing the **Power key** again or receiving an incoming call will turn on your phone screen and show the lock screen.



To save battery power, the phone automatically turns off the screen after a certain period of time when you leave it idle. You will still be able to receive messages and calls while the phone's screen is off.

Note: For information on how to adjust the time before the screen turns off, see [Display Settings](#).

Turn the Screen On and Unlock It

1. To turn the screen on, press the **Power key**.
 - ❖ The lock screen appears.
2. Swipe your finger across the screen to unlock it.
 - ❖ The screen is unlocked.
 - If you have set up a screen lock, you will be prompted to draw the pattern, enter the password or PIN, or scan your fingerprint or iris. See [Screen Lock](#).

Update Your Phone

From time to time, updates may become available for your phone. You can download and apply updates through the **Apps**  > **Settings**  > **System Update**  > **Download updates manually** menu.

Software Update Cautions

During update: The phone cannot be used until the software update is complete. It may take time to update your phone's software.

Signal during update: Update your phone where signal reception is good, and do not change location during the update process. Make sure the battery is adequately charged before beginning an update. A weak signal or low battery during an update may cause the update to fail. An update failure may disable the phone.

Other functions during update: Other phone functions cannot be used during a software update.

Update Your Phone Software



You can update your phone's software using the System Update option.

Before Updating Your Phone



Updating your phone may result in a loss of saved data depending on the condition of your phone (malfunctioning, damaged, water seepage, etc.). You must back up all critical information before updating your phone firmware.

Back Up All Data Prior to Update



To back up your Gmail information:

1. From home, tap **Apps**  > **Settings**  > **Cloud and accounts**  > **Accounts** > **Google**.
2. Tap **On/Off** next to each option to enable backup.
3. Tap **More** > **Sync now** to sync your Google Account information.

To back up your Exchange Mail information:

1. From home, tap **Apps**  > **Settings**  > **Cloud and accounts**  > **Accounts** > **Microsoft Exchange ActiveSync**.
2. Tap **On/Off** next to each option to enable backup.
3. Tap **More** > **Sync now** to sync your Google Account information.



To back up stored text messages:

1. From home, tap **Apps**  > **Messages** .
2. Select the text message from the list to view the message thread.
3. Touch and hold on a portion of the text message from the string. The Message options context menu appears.



Note: You can back up stored text messages by forwarding them to your own phone number. Open the messages after you have updated your firmware.

4. Tap **Forward**.
5. Enter your phone number and tap **Send**.

To restore your Google apps following the update:

1. From home, tap **Apps**  > **Play Store** .
2. Tap **Menu**  > **My apps & games** > **All** tab.
3. Scroll through the list of previously downloaded Google apps and choose those you wish to reinstall.
4. Follow the prompts.

Note: Your Google app purchases are reloaded remotely and can be re-installed after the update is applied.

As an added precaution, to preserve any data on your optional microSD card (not included), please unmount it from your phone prior to starting the update process. From home, tap **Apps**  > **Settings**  > **Device maintenance**  > **Storage** > **More options** > **Storage settings** > **SD card** > **Unmount**.

Update Your Phone's Software

Once you have backed up all your data, use the **Update now** option to update your phone's software.

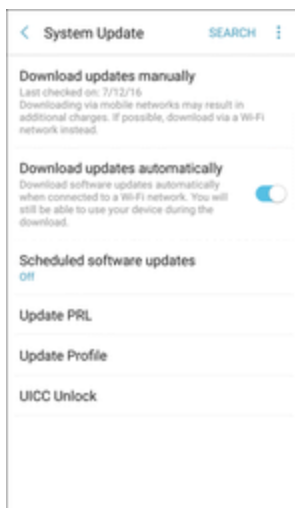

1. From home, tap **Apps**  > **Settings**  > **System Update**  > **Download updates manually**.





2. Tap **Download updates manually**.

- ❖ Your phone automatically downloads and installs any available updates. You may be required to power your phone off and back on to complete the software upgrade.

Alternatively, you can access system updates through the notification panel.

1. Locate the **System Update Available** icon () in notifications.
2. Pull down the status bar.
3. Tap  to open the System Updates screen.
4. Tap **Download** and follow the prompts.
 - ❖ The downloading icon () appears within the status bar to indicate the phone is downloading the necessary files.
5. Tap **Restart** and install to complete the process.

Confirm Your Current Phone Software

1. From home, tap **Apps**  > **Settings**  > **About device** *i* > **Status**.
2. Locate the Software version read-only field.

Your Phone's Home Screen

The following topics describe how to use and customize your phone's home screen, understand the status bar, and use the notification panel.

Home Screen Basics

The home screen is the starting point for your phone's applications, functions, and menus. You can customize your home screen by adding application icons, shortcuts, folders, widgets, and more.

Home Screen Layout

Your home screen extends beyond the initial screen. Swipe the screen left or right to display additional screens.



Item	Description
Status bar	The status bar displays icons to notify you of your phone's status (on the right side) and notifications (on the left side).
Status area	The status area of the status bar (on the right) displays phone and service status information such as signal strength, battery status, Wi-Fi and data connectivity, ringer status, and time.

Item	Description
Notification area	The notification area of the status bar (on the left) displays notifications for incoming messages, missed calls, application updates, and more. Pull down the status bar to display the notification panel.
Widget	Widgets are self-contained apps that reside on your phone's home screen.
Application icons	Application icons are shortcuts to favorite applications. You can add and remove these shortcuts as you wish.
Applications (Apps) list 	Tap to open the applications (apps) list. The Apps list key is a primary shortcut available from all home screens.
Primary shortcuts	Primary shortcuts are application shortcuts that appear in the same location on all of your phone's home screens. These are customizable except for the Applications (Apps) shortcut, which remains static.

Tip: Press the **Home** key to return to the main home screen from any other screen.

Extended Home Screens

In addition to the main home screen, your phone features extended home screens to provide more space for adding icons, widgets, and more. Press the **Home** key to display the main home screen and then swipe the screen right or left to move from the main screen to an extended screen.

Additional screens are available in addition to the main home screen.

- If you are not already using the maximum number of screens for your phone, you can add more screens by touching and holding an empty space on a home screen, sliding the thumbnails to the left, and then tapping **Add page** .
- While on an extended screen, press the **Home** key to return to the main home screen.

Status Bar and Notification Panel

Your phone's status and notifications are available at a glance at the top of the screen.

Status Bar





The status bar at the top of the home screen provides phone and service status information on the right side and notification alerts on the left. To view the notification panel or access the quick settings menu, pull down the status bar from the top of the screen.

Status Bar Layout



















Main Status Icons

Icon	Status
	Bluetooth: Bluetooth is active.
	GPS: GPS is active.
	Wi-Fi: Wi-Fi is active.
	File download in progress: Download of a file or app is in progress.
	Mute mode: Mute mode is enabled.
	Vibrate mode: Vibrate mode is enabled.
	Speakerphone: Call is using speakerphone.
	Signal strength: Cellular network signal strength is displayed.
	Roaming signal strength: Roaming network signal strength is displayed.
	3G: The device is connected to a 3G wireless network.
	4G LTE active: The device is connected to a 4G LTE™ wireless network.
	Airplane mode: Airplane mode is active.

Icon	Status
	Sync: Sync is active.
	Battery charging: Battery is charging.
	Battery full: Battery is fully charged.
	Mobile hotspot: Connected as a mobile hotspot.

Main Notification Icons

Icon	Notification
	Missed call: A call has been missed.
	Call on hold: A call is on hold.
	New voicemail: New voicemail message has been received.
	New email: New email has arrived.
	New Gmail: New Gmail has arrived.
	New message: New text or MMS message
	New Hangouts message: New Hangouts message has arrived.
	New Sprint Zone message: New Sprint Zone message has arrived.
	Event: A calendar event is approaching.
	USB: A USB connection is active.
	Alarm: An alarm has been set.
	Emergency alert: A new Emergency alert has arrived.
	Update available: An app update is available from the Google Play store.
	File upload in progress: File is being uploaded or sent.
	Update successful: An app update was successful.
	Keyboard in use: Keyboard is in use.
	More notifications available: View additional notifications.

Note: Additional notification icons may appear. All notifications may be accessed through the notification panel.

Notification Panel

Your phone's notifications appear at the left side of the status bar, and you can access the full notification panel by pulling down the status bar. From there, you can check notifications, download updates, open messaging apps, use the quick settings menu, and more.

Open the Notification Panel

1. Pull down the status bar. (Slide your finger down from the top of the screen.)

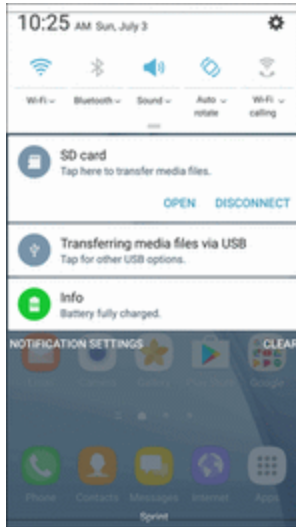

❖ The notification panel opens.

2. Drag down **Expand**  to display additional quick settings.

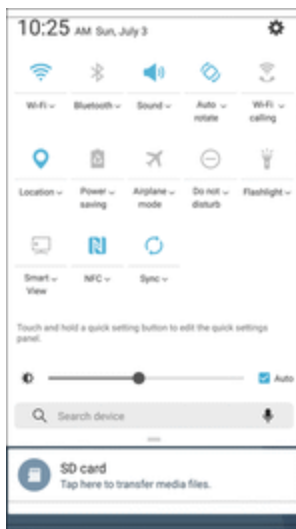

Close the Notification Panel

- Slide the notification panel up. (Slide your finger up from the bottom of the screen.)

– or –

Tap **Back**  to close the notification panel.

Notification Panel Layout

The notification panel gives you access both to notifications and the quick settings menu.

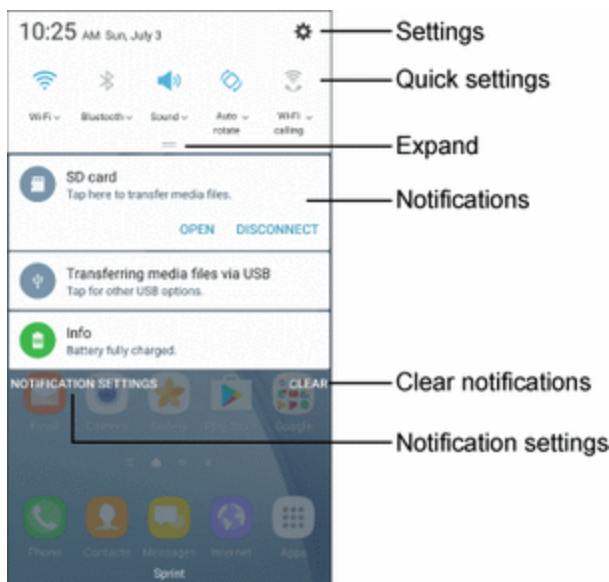

Item	Description
Settings	Display the Settings screen.
Quick settings	Quickly enable or disable a feature.
Expand	See all available Quick settings, adjust screen brightness, and more.
Notifications	View details about notifications.
Clear notifications	Clear all notifications.
Notification settings	Configure settings for notifications.

Notification Panel Quick Settings

The Quick Settings list at the top of the notification panel lets you quickly access frequently used settings options. Scroll left or right to display all available settings, and tap an icon to turn the selected feature on or off.

You can customize which settings are available in your Quick Settings list.

1. Pull down the status bar.

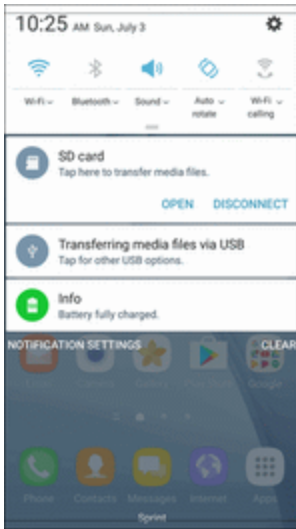

❖ The notification panel opens.

2. Drag down **Expand**  to display additional quick settings.

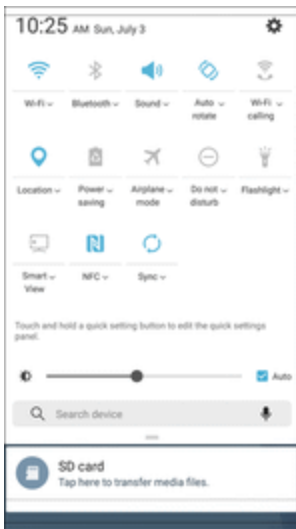

3. Touch and hold a quick setting to edit the quick settings menu.

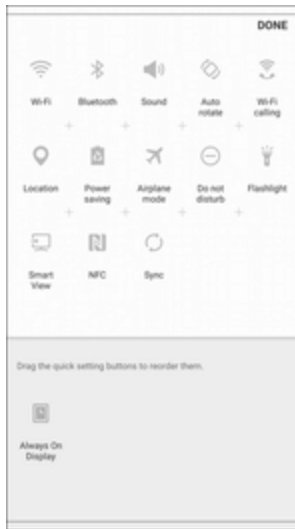

4. Drag buttons to arrange which options appear in the quick settings panel.
5. Tap **Done** when you are finished.

Search Device

Search your device for apps, contacts, messages, email, files, settings, and more.

1. Pull down the status bar. (Slide your finger down from the top of the screen.)

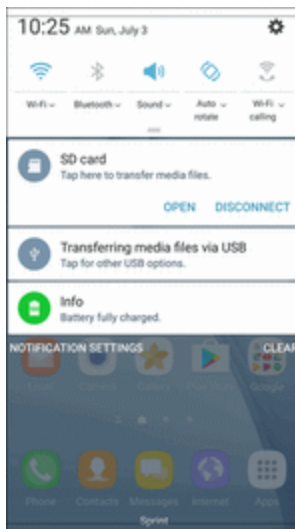

❖ The notification panel opens.

2. Drag down **Expand**  to display additional quick settings.

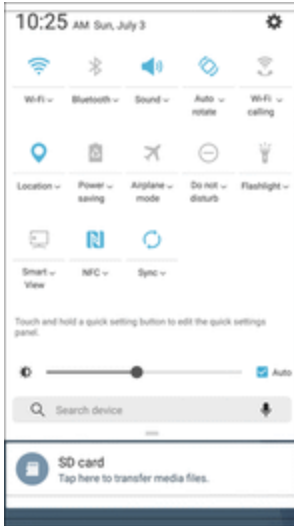

3. Tap the **Search device** field and enter search criteria in the **Search** field.
4. Tap an item to view or launch.

Multi Window

The Multi window™ feature lets you multitask by using multiple applications at the same time.

Activate Multi Window

Apps that support Multi window display together on a split screen. You can switch between the apps, adjust the size of their display on the screen, and copy information from one app to the other.



Note: Multi window is not available for all apps.

1. From any screen, touch and hold **Recent apps** .
2. Tap two apps that support Multi window to open them in split screen view.

– or –

If you are currently using an app that supports Multi window, tap another app to add it in split screen view.

You can also launch recently used apps directly into Multi window view:







1. From any screen, tap **Recent apps** 
 - Recently used apps that support Multi window have a **Multi window**  icon in their title bar.
2. Tap **Multi window**  in the title bar to launch an application in split screen view.
 - Other recently used apps that support Multi window display below the launched app.

3. Tap an app shortcut to add it to the split screen view.

Note: Only applications that support Multi window have the Multi window icon.

Window Controls

Use Window controls to switch windows, drag and drop content, minimize or maximize windows, or to close a window.

1. Select an app window, and then tap **Window controls**  in the middle of the window border.
2. The following options are available:
 -  **Switch windows:** Switch locations between Multi window apps.
 -  **Drag and drop content:** Move items between the app windows. Drag an item to share from one window to another. Not all applications support this feature.
 -  **Minimize window:** Minimize the selected app window. This turns the app into a circular, movable icon that can be opened by tapping on it.
 -  **Maximize window:** Open the selected app window in full screen view.
 -  **Close app:** Close the selected app.

Customize the Home Screen

Learn how to set the wallpaper and add, move, or remove shortcuts, widgets, and folders from the home screen.

Operations for Rearranging the Home Screen



- **Moving Widgets and Icons:** From home, touch and hold an item, and then drag it to the desired location.
- **Deleting Widgets and Icons:** From home, touch and hold an item, and then drag it to **Remove** .
- **Displaying the Home Screen Menu:** From home, touch and hold an empty space to display the home screen menu. Menu options include Wallpapers and themes, Widgets, and Screen grid settings. You also have the option to add or remove home screens.

Change the Wallpaper

Select and assign your phone's background wallpaper.

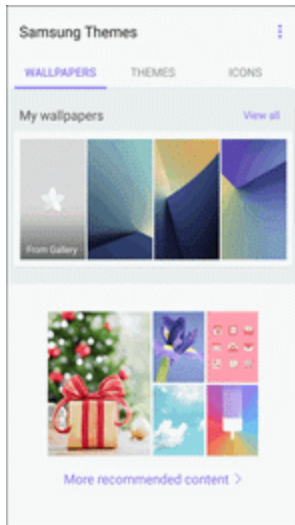
1. From home, touch and hold an empty space, and then tap **Wallpapers and themes** .



- You can also access the wallpaper menu through settings. From home, tap **Apps**  > **Settings**  > **Wallpapers and themes** .
2. Tap an option to select the wallpaper, and then select:
 - **Home screen** to set the background wallpaper for your home screen.
 - **Lock screen** to set the wallpaper for your phone's lock screen.
 - **Home and lock screens** to set a wallpaper for both your home screen and your lock screen.
 3. Tap **Set as wallpaper**.
 - ❖ The wallpaper is set.

Note: Tap **On/Off** next to **Wallpaper motion effect** to enable or disable this feature. It allows the wallpaper to shift slightly as you move the device, creating a 3D effect.

Add Shortcuts to the Home Screen

You can add shortcuts for quick access to favorite apps from the home screen.

1. From home, tap **Apps** .
 - ❖ The Apps list opens.
2. Touch and hold an app icon.
 - ❖ The icon will disengage and you will see the current home screen.
3. Drag the icon to an empty location on the home screen.
 - ❖ The shortcut is added to the home screen.

Add Widgets to the Home Screen

You can add widgets to your phone's home screen. Widgets are self-contained apps that display on a home screen. Unlike a shortcut, the Widget works like as an onscreen application. There are all kinds of widgets, including links to a specific contact, Internet bookmarks, Facebook status windows, Gmail and email accounts, and many others.

1. From home, touch and hold an empty space, and then tap **Widgets** .

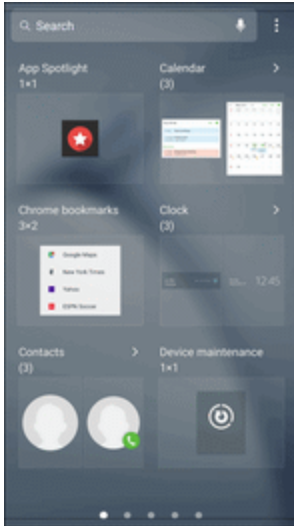

- ❖ The Widgets list opens.
2. Touch and hold a widget icon.
 - ❖ The icon will disengage and you will see the current home screen.
3. Drag the icon to an empty location on the home screen.
 - ❖ The widget is added to the home screen.

Add Folders to the Home Screen

You can group home screen shortcuts into folders for convenient access.

1. From home, touch and hold a shortcut you want to place in a folder, and then drag it on top of another shortcut and release it.

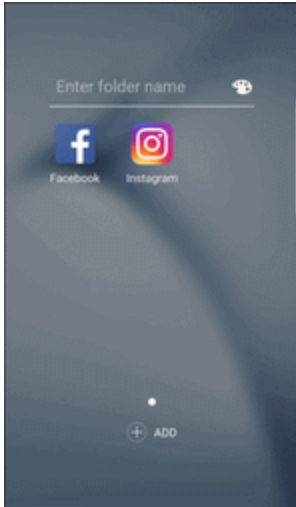

2. Type a name, and then tap **Back** .

❖ A new folder is created.

3. To add more app shortcuts to the folder, touch and hold a shortcut, and then drag it on top of the new folder.

❖ The new shortcut is added to the folder.

Change Folder Names

Once you have added folders, you can change the name easily from the folder display.

1. From home, tap the folder to open it, and then tap the folder name.

2. Type a new name, and then tap **Back** .

Change the Folder Color

You can change the color of a folder.

1. From home, tap the folder to open it.

2. Tap  and select a color, and then tap **Back** .

Making Connections

The topics in this section will cover your phone's ability to help you make connections, from phone calls and maintaining contacts, to text messages, email, Internet, and international services.

Phone Calls and Voicemail

The following topics outline the use of your device's phone app to place and receive calls, use voicemail, and more.

Place and Answer Calls

The following topics describe how to directly dial calls, how to answer incoming calls, and how to use the in-call screen options.

Adjust In-Call Volume

- **Adjusting Call Volume:** Press the **Volume** key up or down during the call.

Troubleshooting

Problem: Difficulty during call.

Solution 1: It may not be possible to make a call properly in a noisy location.

Solution 2: When calling using Speaker, check the call volume. Raising the call volume may make calling difficult.

Problem: Sound pops momentarily during a call.



Solution: Are you changing location while calling? Sound pops when signal is weak and the phone switches to a different area.

Emergency Call Cautions

Emergency calls are restricted in Airplane mode.

Call Using the Phone Dialer

The most “traditional” way to place a call is by using the phone's dialer screen.

1. From home, tap **Phone**  to display the phone screen.
 - ❖ The phone app opens. If necessary, tap **Keypad**  to display the dialer screen.
2. Tap the number keys on the keypad to enter the phone number.

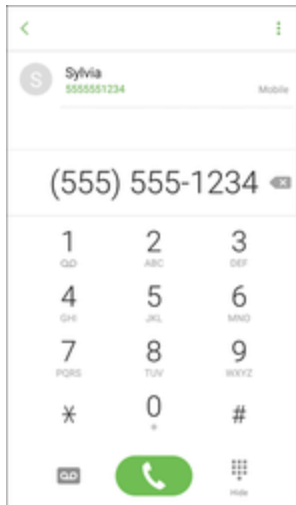

- As you enter digits, Smart Dial searches for contacts that match. If you see the number you want to dial, tap it to place the call immediately without entering the rest of the number.

3. Tap **Dial**  to call the number.

❖ The phone dials the number. The call begins when the other party answers.

❖ To end the call, tap **End** . The call ends.

Troubleshooting

Question: Call does not connect.

Answer 1: Was the number dialed using the area code? If not, try dialing using the full 10-digit number including the area code.

Answer 2: Are you in an area with poor wireless coverage? Try calling again from another area.

Call Emergency Numbers

You can place calls to 9-1-1 even if the phone's screen is locked or your account is restricted.







To call the 9-1-1 emergency number when the phone's screen is locked with a screen lock:

1. From the lock screen, swipe **Phone**  up, and then tap **Emergency call**.

2. Tap **9-1-1** (  ) , and tap **Dial** .

❖ As long as you are in an area covered by wireless service, the emergency call is placed.

To call the 9-1-1 emergency number normally or when your account is restricted:

1. Unlock the screen. For more information, see [Lock and Unlock Your Screen](#).
2. From home, tap **Phone**  > **Keypad** .
3. Tap **9-1-1** (  ) , and tap **Dial** .

❖ As long as you are in an area covered by wireless service, the emergency call is placed.

Enhanced 9-1-1 (E 9-1-1) Information

This phone features an embedded Global Positioning System (GPS) chip necessary for utilizing E 9-1-1 emergency location services where available.

When you place an emergency 9-1-1 call, the GPS feature of your phone seeks information to calculate your approximate location. Depending on several variables, including availability and access to satellite signals, it may take up to 30 seconds or more to determine and report your approximate location.

Important: Always report your location to the 9-1-1 operator when placing an emergency call. Some designated emergency call takers, known as Public Safety Answering Points (PSAPs), may not be equipped to receive GPS location information from your phone.

Answer Phone Calls

The following information lets you know how to answer incoming calls, mute the ringer on incoming calls, reject incoming calls, and more.

When you receive a phone call from a contact, the Incoming call screen appears and displays the caller ID icon, name, and phone number of the calling party. When you receive a phone call from someone who is not stored in Contacts, only the default caller ID icon and phone number appear on the Incoming call screen.

Note: If your phone is turned off, all calls automatically go to voicemail.

Answer an Incoming Call

1. When a call arrives, slide **Answer**  to the right to answer it.

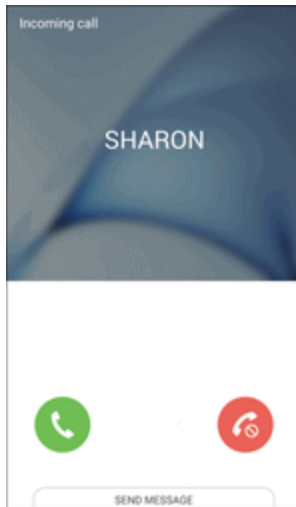

❖ The call begins.

2. To end the call, tap **End** .

❖ The call ends.

Mute the Ringing Sound

To mute the ringer without rejecting the call, you can do either of the following:

- Press the **Volume** key down.
- Place the phone face down on a level surface.

Reject an Incoming Call

- When a call arrives, slide **Reject**  to the left to reject it.

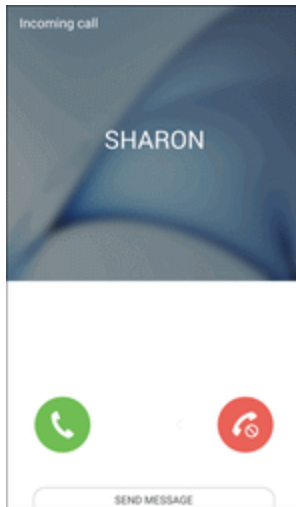

- ❖ The ringtone or vibration will stop and the call will be sent directly to voicemail.

Reject a Call and Send a Text Message

You can reject an incoming call and automatically send a text message to the caller.

1. When a call arrives, slide **Send message** up from the bottom of the screen.

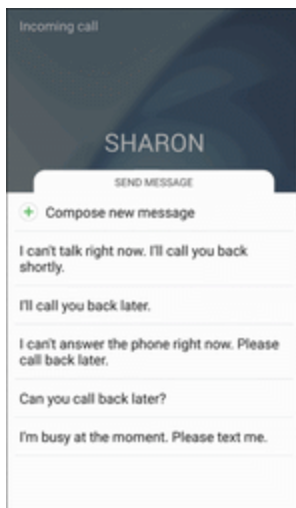

- ❖ The ringtone or vibration will stop and you will see a list of preset text messages.
2. Tap one of the messages to send it to the caller.
- ❖ The selected message will be delivered to the caller.
 - You can edit the reject messages through the Call settings menu. From the phone app, tap **More options** > **Settings** > **Quick decline messages** and edit or create a reject message.

In-Call Screen Layout and Operations

While you are on a call, you will see a number of options.

In-Call Screen Layout

- Tap options to activate them during a call.

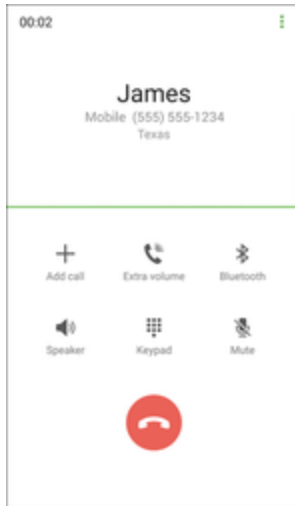

- **Add call:** Touch and hold to initiate a conference call (3-way call).
- **Merge:** Join two currently active calls (conference).
- **Extra volume:** Increase the call volume.
- **Bluetooth:** Route the phone's audio through a connected Bluetooth headset (On) or through the speaker (Off).
 - When the call is routed to a Bluetooth headset, the current call area shows the **Bluetooth call** icon .



Note: The Headset button is activated to show the current call is routed to the connected Bluetooth headset (not included).

- To route the current call back to the phone, tap **Headset** to temporarily use the phone. Tap it again to route the call back to the connected Bluetooth headset.
- **Speaker:** Route the phone's audio through the speaker (On) or through the earpiece (Off).
 - Activate **Speaker** to route the phone's audio through the speaker. (You can adjust the speaker volume using the **Volume** key.)
 - Deactivate **Speaker** to use the phone's earpiece.

Warning: Because of higher volume levels, do not place the phone near your ear during speakerphone use.

- **Keypad/Hide:** Toggle the appearance of the onscreen keypad. Show the keypad to enter additional numbers, for example, an extension or access code.
 - For example: When you call your bank's 800 number, use the keypad to enter your account number and PIN.
- **Mute:** Mute the microphone during an active call. Tap again to unmute the microphone.

Note: If Mute is activated, the speaker mode is deactivated.

- **End** : End the current call.
- Tap **More**  during a call to display a list of additional in-call features:
 - **Contacts:** Display your Contacts list.
 - **Message:** Send a text or multimedia message while remaining on the call.
 - **Memo:** Create a new memo while remaining on the call.
 - **Calendar:** View your calendar while remaining on the call.



Place a Call from Contacts

You can place phone calls directly from entries in your Contacts list.

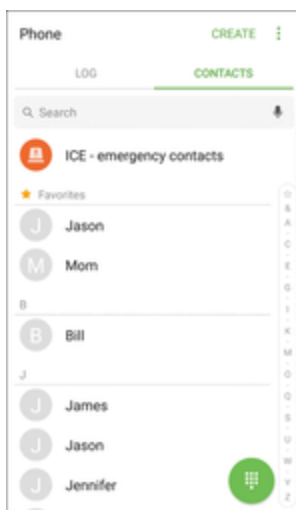
1. From home, tap **Phone**  to display the phone app.
2. Tap **Contacts** to display the Contacts list.



 The contacts list appears.

3. Tap a contact.
4. Tap **Call**  next to the number you want to call.
 - ❖ The phone dials the number. The call begins when the other party answers.
5. To end the call, tap **End** .
 - ❖ The call ends.

Tip: You can also place a call directly from the Contacts list. Swipe the entry you want to call from left to right to place a call to the entry's primary number.



Call from Call Log

The call log list lets you quickly place calls to recent incoming, outgoing, or missed numbers.

1. From home, tap **Phone**  to display the phone app.
2. Tap **Log** to display the call log list.

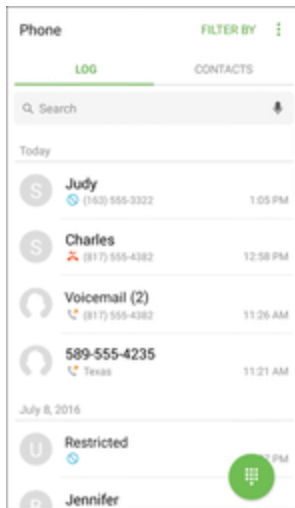

- ❖ The call log list appears.
3. Tap an entry to display the call details.
 4. Tap **Call**  to place a call.
 - ❖ The phone dials the number. The call begins when the other party answers.
 - For additional options, tap the name or number.

5. To end the call, tap **End** .

- The call ends.

Tip: You can also place a call directly from the call log list. Swipe the entry you want to call from left to right to place a call.



Voicemail Setup

Follow the instructions below to set up voicemail on your phone. You should set up your voicemail and personal greeting as soon as your phone is activated. Always use a passcode to protect against unauthorized access. Your phone automatically transfers all unanswered calls to your voicemail, even if your phone is in use or turned off.

1. From home, tap **Phone**  > **Keypad**.
2. Touch and hold the **1** key to dial your voicemail number.

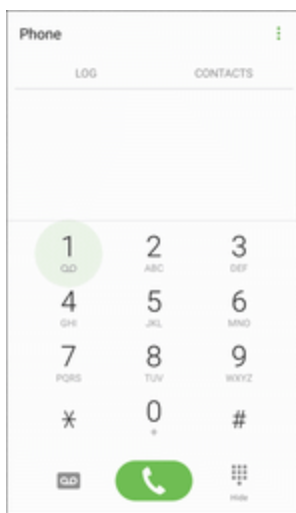

❖ Your phone dials the voicemail access number.

3. Follow the system prompts to:
 - Create your passcode.
 - Record your name announcement.
 - Record your greeting.

Important: Voicemail Passcode – It is strongly recommended that you create a passcode when setting up your voicemail to protect against unauthorized access. Without a passcode, anyone who has access to your phone is able to access your voicemail messages.

Visual Voicemail

This topic describes the Visual Voicemail feature of your phone's service, as well as the steps required to set up Visual Voicemail on your phone.

About Visual Voicemail

Visual Voicemail gives you a quick and easy way to access your voicemail. Now, you can find the exact message you are looking for without having to listen to every voicemail message first. This feature periodically goes out to your voicemail, and gathers the caller information from all of the current voicemails. It then populates a list with the caller name and number, along with the length of time and priority level of the voicemail message.

Set Up Visual Voicemail

Setting up Visual Voicemail follows many of the same procedures as setting up traditional voicemail. You should set up your voicemail and personal greeting as soon as your phone is activated. Your phone automatically transfers all unanswered calls to your voicemail, even if your phone is in use or turned off.

Note: To set up your traditional voicemail box, see [Voicemail Setup](#).

1. From home, tap **Apps**  > **Voicemail** .

– or –

Tap **Phone** , and then tap **Voicemail**  to access your Visual Voicemail.

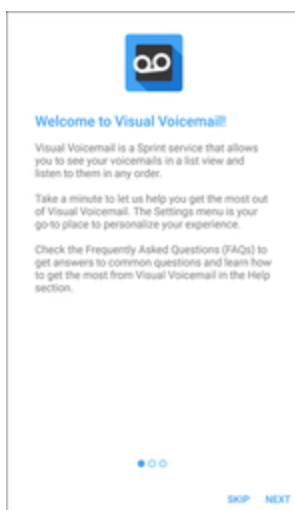

- ❖ You will see a Welcome to Visual Voicemail screen.
- 2. Scroll through the Welcome to Visual Voicemail introduction screens to view a brief explanation of the visual voicemail services.
- 3. At the end of the welcome screens, a Personalize your voicemail prompt displays.

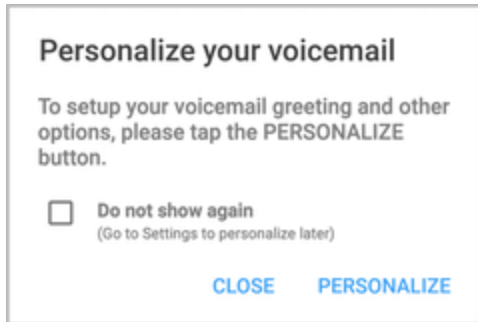

- ❖ You will see a Personalize your voicemail prompt.
- 4. Tap **Personalize now** and follow the system prompts to:
 - Create a passcode (part of standard voicemail).
 - Record your name announcement.
 - Record your greeting.

Important: Voicemail Passcode – It is strongly recommended that you create a passcode when setting up your voicemail to protect against unauthorized access. Without a passcode, anyone who has access to your phone is able to access your voicemail messages.

Review Visual Voicemail

Visual Voicemail lets you easily access and select which messages you want to review.

1. From home, tap **Apps**  > **Voicemail** .



❖ You will see the voicemail inbox.

2. Tap a message, and then tap **Play**  to review it.

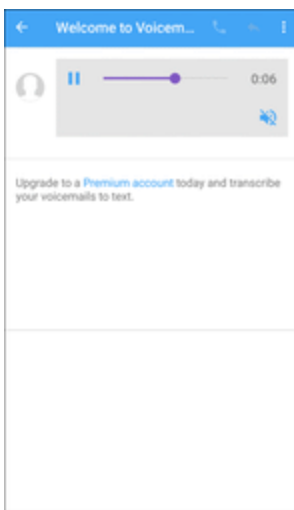





Tip: For an explanation of all your Visual voicemail options, tap **More options**  > **Help** > **Visual Voicemail Menu** > **Visual Voicemail Settings**.



Visual Voicemail Options

Your visual voicemail options appear as icons at the bottom of the voicemail review screen.

1. From home, tap **Apps**  > **Voicemail** .



2. The following options are available when viewing the voicemail inbox.
 - **More options** : Access Search, Settings, and Help features.
 - **New Voice SMS**: Send a voice message to friends.
 - **New Avatar message**: Send an animated voice message to friends.
 - **Search**: Search your voice messages.
 - **Upgrade to Premium**: Subscribe to the premium Voice-to-Text transcription service. This service requires an additional monthly charge.
 - **Store**: Access the Visual Voicemail store to purchase avatars, backgrounds, and more.
 - **Help**: View help topics for Visual Voicemail.
 - **Settings**: Customize your Visual Voicemail settings.
3. Tap a message to review it. The following options are available while listening to voicemail messages.
 - **Call** : Dial the number the message came from.
 - **Reply** : Reply to the message using text or voice message.
 - **More options** : Access Archive, Settings, and Help features.
 - **Delete**: Delete selected messages.
 - **Share**: Send the message using Wi-Fi Direct, social accounts, and so on.
 - **Archive message**: Save this message.

- **Upgrade to premium:** Subscribe to the premium Voice-to-Text transcription service. This service requires an additional monthly charge.
 - **Help:** View help topics for Visual Voicemail.
 - **Settings:** Customize your Visual Voicemail settings.
4. Touch and hold a message to manage your messages. The following options are available:
- **Delete** : Delete selected messages.
 - **More options** : Select additional options.
 - **Archive:** Save this message.
 - **Mark as Read:** Mark this voicemail as being read.
 - **Mark as Unread:** Mark this voicemail as not being read.

Configure Visual Voicemail Settings

The Visual Voicemail settings menu lets you access settings for notifications, pictures, greetings, and more.

1. From home, tap **Apps**  > **Voicemail** .



2. Tap **More options**  > **Settings**.



❖ You will see the voicemail settings menu.

3. Select an option to change its settings:

- **Avatar:** Configure you Avatar options.
- **Display:** Change your voicemail message theme and enter a name to identify yourself to people when replying or forwarding messages.
- **Help/Info:** View help topics for using Visual Voicemail.
- **Preferences:** Change your Visual Voicemail application preferences.
- **Sound:** Change your sound/speakerphone options.
- **Updates:** Check for updates.
- **About Voicemail:** View information about the application.

Change Your Main Greeting Using the Voicemail Menu

Your main greeting can be changed directly using the Visual Voicemail system. This direct access saves you from having to navigate within the voicemail menu.

1. From home, tap **Apps**  > **Voicemail** .



2. Tap **More options**  > **Settings** > **Preferences** > **Personalize voicemail**.
3. Tap **OK** to connect to the voicemail system. Follow the prompts to change your current greeting.

Edit the Display Name Using the Voicemail Menu

From your Visual Voicemail menu, you can quickly change the name or number attached to your voice messages.

1. From home, tap **Apps**  > **Voicemail** .



2. Tap **More options**  > **Settings** > **Display** > **Display name**.
3. Tap the existing identification field and enter a new identifying name or number (used to identify you to recipients of your voice messages).
4. Tap **OK** to save your information.

Optional Calling Services



The following topics outline additional voice-related services available with your phone, including Wi-Fi calling, call services and more.

Wi-Fi Calling



Wi-Fi Calling uses Wi-Fi networks to help improve voice and data coverage. It sends and receives calls and text messages over a connected Wi-Fi network and may offer better coverage in buildings and areas of poor cellular reception.



Note: Wi-Fi Calling may not be available on your phone at launch.

Set Up Wi-Fi Calling

1. From home, tap **Apps**  > **Settings** .
2. Tap **Wi-Fi Calling**  and follow the prompts to set up Wi-Fi Calling.





- ❖ You will see  in the status bar when Wi-Fi Calling is active and connected, or  if Wi-Fi Calling is set up but you are not connected to a Wi-Fi network.

Note: When using Wi-Fi calling, the phone app icons differ slightly. You will tap **Dial**  to place a call, and tap **End**  to end a call.

Tip: For more information about Wi-Fi Calling, visit this FAQ link at sprint.com/support.

Enable or Disable Wi-Fi Calling





1. From home, tap **Apps**  > **Settings**  > **Wi-Fi Calling** .
2. Tap **On/Off** to turn Wi-Fi Calling on or off.

- ❖ Wi-Fi Calling will be turned off, and the Wi-Fi Calling icon will not appear in the status bar.

Tip: You can also turn Wi-Fi Calling on or off through the quick settings menu. Pull down the status bar to display the quick settings menu and tap **Wi-Fi Calling**  to enable or disable the feature.

Caller ID Blocking

Caller ID identifies a caller before you answer the phone by displaying the number of the incoming call. If you do not want your number displayed when you make a call, follow these steps.

1. From home, tap **Phone**  > **Keypad**.
2. Tap * 6 7 (  ).
3. Enter a phone number.
4. Tap **Dial** .

- ❖ Your caller information will not appear on the recipient's phone.

To permanently block your number, call Sprint Customer Service.

Call Waiting

When you are on a call, Call Waiting alerts you to incoming calls by sounding two beeps. Your phone's screen informs you that another call is coming in and displays the caller's phone number (if it is available).

To respond to an incoming call while you are on a call:

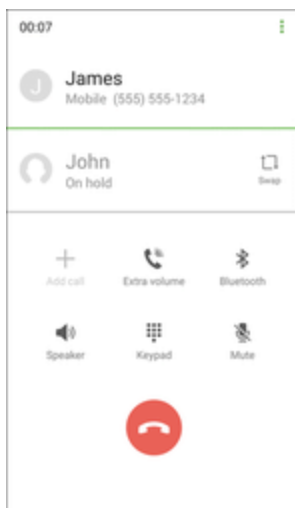

- Slide **Answer**  to the right. (This puts the first caller on hold and answers the second call.)

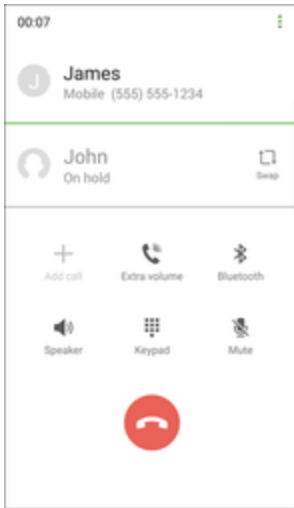

To switch back to the first caller:

■ Tap **Swap** .



Note: For those calls where you do not want to be interrupted, you can temporarily disable Call Waiting by pressing * 7 0 (  ) before placing your call. Call Waiting is automatically reactivated once you end the call.

Conference Calling

With conference calling, also known as 3-way calling, you can talk to two people at the same time. When using this feature, the normal airtime rates will be charged for each of the two calls.

1. On the Phone screen, enter a number and tap **Dial**  (or place a call from Log or Contacts).
2. Once you have established the connection, tap **Add call**, and dial the second number (or place the call from Log or Contacts).

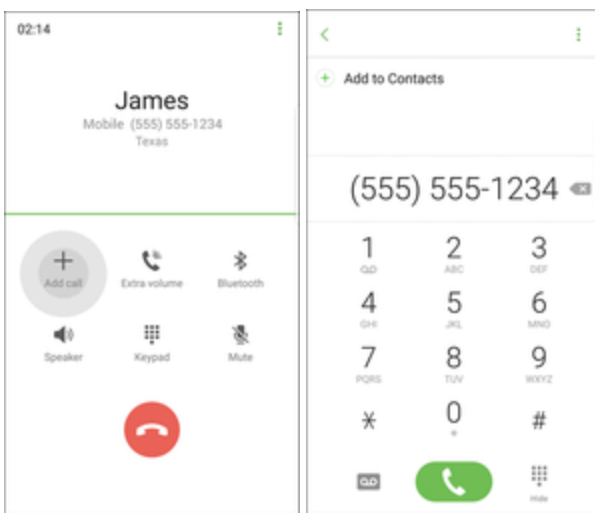

❖ This puts the first caller on hold and dials the second number.

- When you are connected to the second party, tap **Merge** . Your conference call is now in session.

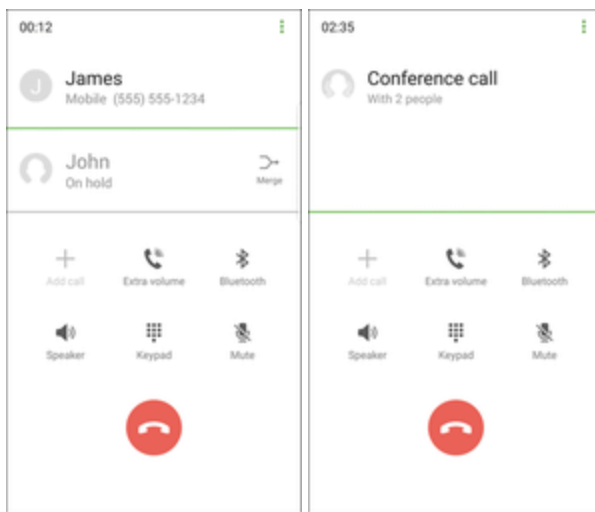

- To end the three-way call, tap **End** .



Note: If one of the people you called hangs up during your call, you and the remaining caller stay connected. If you initiated the call and are the first to hang up, all callers are disconnected.

Call Forwarding

Call Forwarding lets you forward all your incoming calls to another phone number – even when your phone is turned off. You can continue to make calls from your phone when you have activated Call Forwarding.

Note: You are charged a higher rate for calls you have forwarded.

To activate Call Forwarding:

- From home, tap **Phone** .
- Tap .
- Enter the area code and phone number to which you want your calls forwarded.
- Tap **Dial** .

- ❖ You will hear a tone to confirm the activation of Call Forwarding. All calls to your wireless number will be forwarded to the designated phone number.

To deactivate Call Forwarding:

1. From home, tap **Phone** .

2. Tap    .

3. Tap **Dial** .

❖ You will hear a tone to confirm the deactivation.

Call Settings

Your phone's Call Settings menu lets you configure your voicemail options and a number of other settings for the phone application.

Call Settings Options

Use the Call Settings menu to adjust the following settings:

Setting	Description
Swipe to call or send messages	Place a call to a displayed contact by swiping right. Send a message to a displayed contact by swiping left.
Contacts with numbers	Show contacts with phone numbers and hide other contacts.
Block numbers	Manage a list of automatically blocked phone numbers, and create or edit messages to block incoming calls.
Quick decline messages	Compose or edit response messages to send when declining incoming calls.
Answering and ending calls	Answer calls by pressing the Home key or using voice commands. End calls by pressing the Power key or using voice commands.
Call alerts	Vibrate or play tones when calls are answered or ended. Alarms and notifications can be turned off during calls.
Ringtones and keypad tones	Select or create your default ringtone, set the phone to vibrate when ringing, and play a tone when the dialing keypad is tapped.

Setting	Description
More settings	<ul style="list-style-type: none"> ■ TTY mode: Enable service on your phone. ■ Hearing aids: Improve the sound quality of your phone when using hearing aids. ■ US dialing: Replace + with the international dialing code, except when entering +1. ■ International dialing: Enter the international dialing code automatically (only when US dialing is disabled). ■ DTMF tones: Set the length of DTMF tones, which are used when pressing the keypad while on a call.
Voicemail	<ul style="list-style-type: none"> ■ Service provider: View your service provider. ■ Voicemail settings: View your voicemail number. ■ Alert sound: Select your new voicemail alert sound. ■ Vibrate: Set the phone to vibrate when new voicemail arrives. ■ Voicemail: Set options for voicemail. See Voicemail Setup.

Use the Call Settings Menu

1. From home, tap **Phone**  > **More options**  > **Settings**.

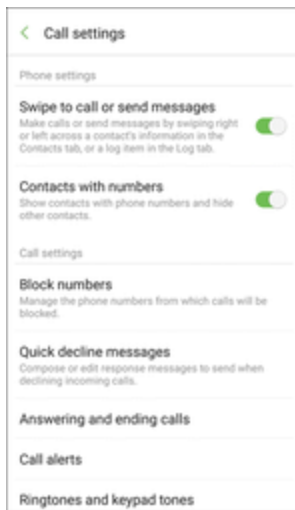

- ❖ The call settings menu appears.

2. Configure your options.

- Tap a menu item to display its options.
- Select your options and follow the prompts to set them.



❖ Your call settings options are set.

TTY Mode

A TTY (teletypewriter, also known as a TDD or Text Telephone) is a telecommunications device that allows people who are deaf, hard of hearing, or who have speech or language disabilities, to communicate by telephone.

Your phone is compatible with select TTY devices. Please check with the manufacturer of your TTY device to ensure that it supports digital wireless transmission. Your phone and TTY device will connect using a special cable that plugs into your phone's headset jack. If this cable was not provided with your TTY device, contact your TTY device manufacturer to purchase the connector cable.

To turn TTY Mode on or off:

1. From home, tap **Phone**  > **More options**  > **Settings**.
2. Tap **More settings** > **TTY mode**.
3. Tap **TTY Full**, **TTY HCO**, or **TTY VCO** to turn TTY mode on.

– or –

Tap **TTY Off** to turn TTY mode off.

❖ Your phone's TTY mode is set.

Note: When enabled, TTY mode may impair the audio quality of non-TTY devices connected to the headset jack.

Warning: 9-1-1 Emergency Calling

It is recommended that TTY users make emergency calls by other means, including Telecommunications Relay Services (TRS), analog cellular, and landline communications. Wireless TTY calls to 9-1-1 may be corrupted when received by public safety answering points (PSAPs), rendering some communications unintelligible. The problem encountered appears related to TTY equipment or software used by PSAPs. This matter has been brought to the attention of the FCC, and the wireless industry and the PSAP community are currently working to resolve this.

Contacts

The Contacts application lets you store and manage contacts from a variety of sources, including contacts you enter and save directly in your phone as well as contacts synchronized with your Google Account, your PC, compatible email programs (including Exchange Server), and your Facebook friends.

⚠ Contacts Cautions

Information saved in Contacts may be lost or changed if the battery is removed for a long period or left uncharged. Accident or malfunction may also cause loss or change to information. It is recommended that you keep a separate copy of contacts and other important information. Sprint is not responsible for any damages from lost or changed contacts.

Add a Contact

You can add contacts from your phone's Phone application. Enter details such as name, phone numbers, email addresses, mailing addresses, and more.

1. From home, tap **Apps**  > **Contacts** .

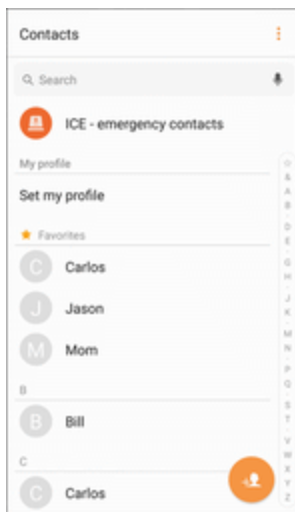

❖ You will see the Contacts list.

2. Tap **Add**  to add a contact.

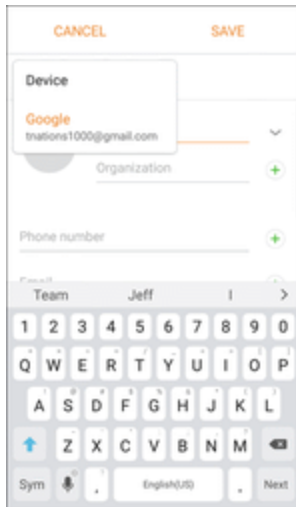

❖ The Add Contact screen appears.

3. If you have multiple account types associated with your phone, select a contact type.
 - Select **Google** if you want to save contacts to your Google Account; these will be synced automatically with your Google Account online.
 - Select **Device** as the sync account if you want your contacts on your phone only; they will not be synced with your Google Account.
 - Select **Samsung account** if you want to save contacts to your Samsung account; these will be synced automatically with your Samsung account online.
4. Use the keyboard to enter as much information as you want.
 - **Picture** : Tap the picture icon to assign a picture to the contact.
 - **Name**: Enter the name of the contact.
 - **Organization**: Enter organization information for the contact.
 - **Phone number**: Enter the phone number for the contact.
 - **Email**: Enter email addresses for the contact.
 - **Groups**: Assign the contact to a group.
 - **More**: Show additional fields such as IM address, Notes, Nickname, Website, etc.
 - **Scan business card**: Take a picture of a business card to add the information for the contact.

Note: To select a type (label) for a phone number, email address, or postal address (such as Mobile, Home, Work, etc.), tap the type to the right of the field and select the appropriate type.

Note: To add more phone numbers, email addresses, etc., tap  on the right side of the entry field.

5. When you have finished adding information, tap **Save**.

❖ The contact is added.

Save a Phone Number

You can save a phone number to Contacts directly from the phone keypad.

1. From home, tap **Phone** .
2. Enter a phone number and tap **Add to Contacts**.

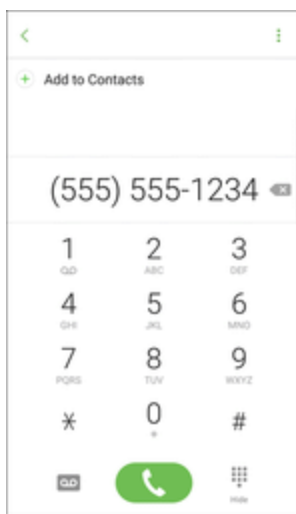

3. To add the number to an existing contact, tap **Update existing**. To add a new contact, tap **Create contact**.
 - For an existing contact, tap the contact name and select a number type for the new number.
 - For a new contact, enter the name and any additional information.

4. Tap **Save**.

❖ The contact is added.

View Contacts



View a contact's details by displaying a contact entry.

1. From home, tap **Apps**  > **Contacts** .

❖ You will see the Contacts list.

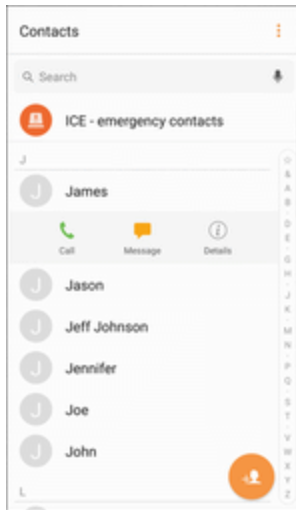
2. Tap a contact to view quick options.



- Tap **Call**  to dial the contact's default phone number.
- Tap **Message**  to send the contact a message.
- Tap **Details**  to view more information about the contact.

Contacts Screen Layout

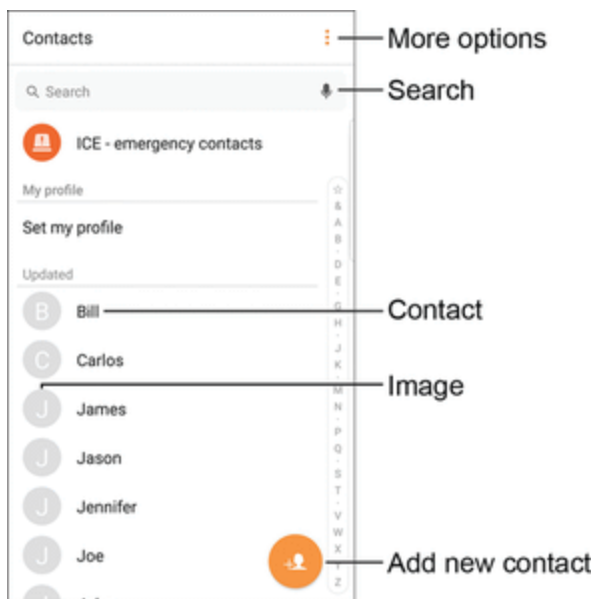

The following illustration show's your Contacts app layout and describes the various features.



Item	Description
More options	Access additional options.
Search	Search contacts.
Contact	Tap to show the contact's details.
Image	Tap to show the contact's details.
Add new contact	Add a new contact.

Edit a Contact

Once you have added a contact, you can add or edit any of the information in the entry, assign a caller ID picture, customize with a unique ringtone, and more.

1. From home, tap **Apps**  > **Contacts** .
- ❖ You will see the Contacts list.
2. Tap a contact, and then tap **Details** .

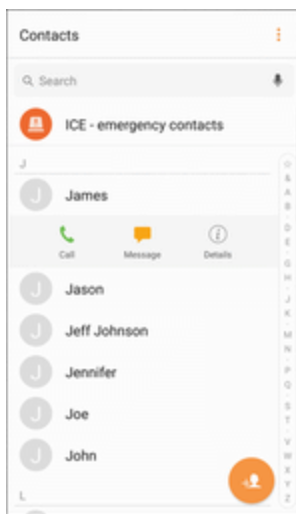

- ❖ The contact's detailed listing appears.
3. Tap **Edit**.

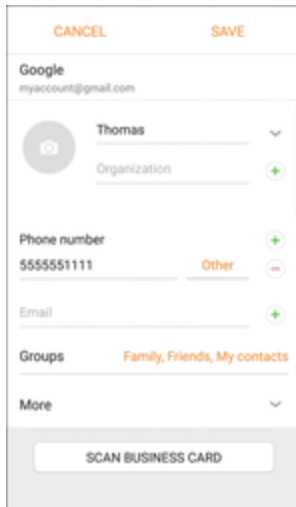



4. Tap any field you want to change or add. See [Add a Contact](#).
5. Add or edit the information, and then tap **Save**.
 - ❖ Your changes are saved to the contact entry.

Note: To select a type (label) for a phone number, email address, or postal address (such as Mobile, Home, Work, etc.), tap the type to the right of the field.

Note: To add more phone numbers, email addresses, etc., tap **+** on the right side of the entry field.

Delete a Contact

You can delete a contact from the contacts details page.

1. From home, tap **Apps**  > **Contacts** .
- ❖ You will see the Contacts list.
2. Tap a contact, and then tap **Details** .

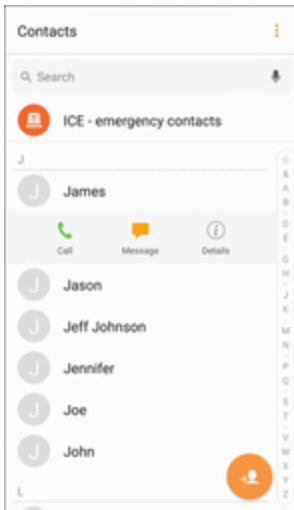

❖ The contact's detailed listing appears.

3. Tap **More options**  > **Delete**.

4. Tap **Delete**.

❖ The contact is deleted.



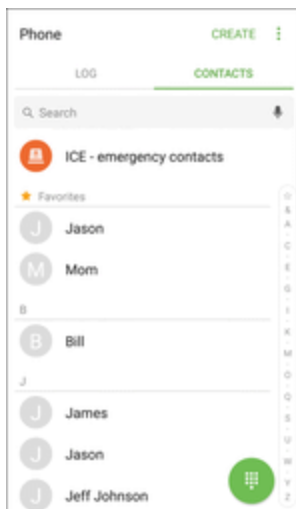

Tip: You can also touch and hold the contact from the contact list and then tap **Delete** > **Delete**.

Favorites





Marking contacts as favorites lists them at the top of the Contacts tab in the Phone app, allowing you to quickly access your most used or preferred Contacts entries.



Mark Contacts as Favorites

1. From home, tap **Apps**  > **Contacts** .
2. Tap a contact, and then tap **Details** .
3. Tap **Favorite**  to turn the star yellow .

Remove Contacts from Favorites

1. From home, tap **Apps**  > **Contacts** .
2. Tap a contact, and then tap **Details** .
3. Tap **Favorite**  to turn the star white .
4. Tap **Done**.

Make a Call from Favorites

1. From home, tap **Apps**  > **Phone**  > **Contacts** tab.

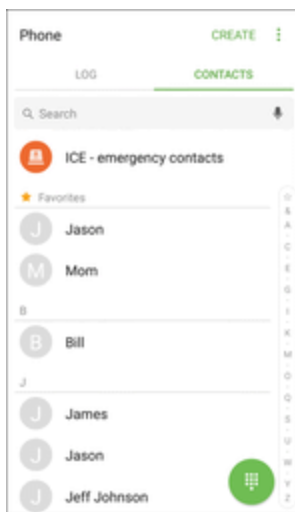



2. Tap a contact to display it, and then tap **Call** .



Groups

You can use groups to organize your contacts. Your phone comes with preloaded groups, and you can create your own. You might create a group for your family, for coworkers, or a team. Groups make it easy to find contacts, and you can send messages to the members of a group.

Create a Group

1. From home, tap **Apps**  > **Contacts** .
2. Tap **More options**  > **Groups**, and then tap **Create**.
3. Tap fields to enter information about the group:
 - Tap **Device storage and all accounts** to choose where to save the group. You can save it to a specific account, to the device memory, or to all accounts.
 - Tap **Group name** to enter a name for the new group.
 - Tap **Group ringtone** to select a ringtone for notifications for incoming calls from group members.
4. Tap **Add member** and select a member or members to add to the new group, and then tap **Done**.
5. Tap **Save** to save the new group.





Add Contacts to a Group

1. From home, tap **Apps**  > **Contacts** .
2. Tap **More options**  > **Groups**, and then tap a group.
3. Tap **Edit** > **Add member** and select a member or members to add to the new group, and then tap **Done**.
4. Tap **Save**.

Send a Message to a Group

You can send a message to members of a group, if the members have a telephone number stored in their contact record.





A message to multiple recipients is treated as a group conversation.

1. From home, tap **Apps**  > **Contacts** .
2. Tap **More options**  > **Groups**, and then tap a group.
3. Tap **More options**  > **Send message**.
4. Tap **Recipients**  to edit the group's members receiving the message.

5. Continue to enter your message and send it. For more information, see [Text and Multimedia Messaging](#).





Send an Email to a Group

You can send an email to members of a group, if the members have an email address stored in their contact record.

1. From home, tap **Apps**  > **Contacts** .
2. Tap **More options**  > **Groups**, and then tap a group.
3. Tap **More options**  > **Send email**.
4. Tap **Recipients**  to edit the group's members receiving the message.
5. Continue to choose an email account, or Gmail, and then enter your email and send it. For more information, see [Create and Send an Email Message](#) or [Create and Send a Gmail Message](#).



Delete a Group

You can delete any group you created. When removing a group, you will have the option to also remove any members of the group from your accounts.

1. From home, tap **Apps**  > **Contacts**  > **Groups**.
2. Tap **More options**  > **Groups**, and then tap a group.
3. Tap **More options**  > **Delete**, and then tap **Group only** to delete only the group, or **Group and members** to delete the group and all of its members.

Share a Contact

You can quickly share contacts using Bluetooth, email, Gmail, or text messaging.

1. From home, tap **Apps**  > **Contacts** .
2. Tap a contact and select **Details** .
3. Tap **Share**.
4. Tap **vCard file (VCF)** to share the contact as a vCard file, or tap **Text** to share the contact information in a text file.

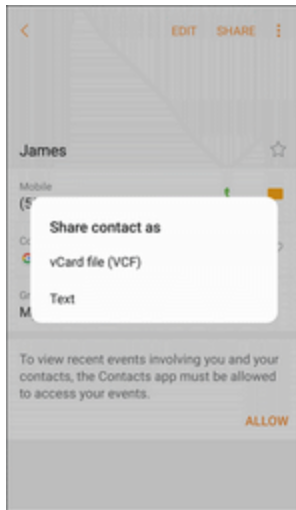

5. Select a sharing method:

- When sharing a contact as a .vcf file, the following sharing methods are available:
 - **Link sharing:** Send large files to others, even to people who are not in your Contacts.
 - **Android Beam:** Send the information using NFC and Android Beam.
 - **Bluetooth:** Send the information using Bluetooth. See [Bluetooth](#) for information on pairing and sending using Bluetooth.
 - **Contacts:** Send the information to your Contacts.
 - **Drive:** Save the information to your Google Drive™ account.
 - **Email:** Send the information as an email attachment. If prompted, select an email account. Address the message, add a subject and a message, and then tap **Send**. See [Create and Send an Email Message](#) for details on sending email.
 - **Gmail:** Send the information as a Gmail attachment. Address the message, add a subject and a message, and then tap **Send** . See [Create and Send a Gmail Message](#) for details.
 - **Messages:** Send the information in a text message. Select a contact or enter a wireless phone number or email address, enter any additional information, and then tap **Send**. For more information on text messaging, see [Send a Multimedia Message \(MMS\)](#).
 - **Wi-Fi Direct:** Send the information to another device using Wi-Fi Direct. See [Wi-Fi Direct](#).
- When sharing a contact as a text file, the following sharing methods are available:
 - **Android Beam:** Send the information using NFC and Android Beam.

- **Bluetooth:** Send the information using Bluetooth. See [Bluetooth](#) for information on pairing and sending using Bluetooth.
- **Copy to clipboard:** Save the information to the clipboard.
- **Drive:** Save the information to your Google Drive account.
- **Email:** Send the information as an email attachment. If prompted, select an email account. Address the message, add a subject and a message, and then tap **Send**. See [Create and Send an Email Message](#) for details on sending email.
- **Gmail:** Send the information as a Gmail attachment. Address the message, add a subject and a message, and then tap **Send** . See [Create and Send a Gmail Message](#) for details.
- **Hangouts:** Send the information using Hangouts.
- **Messages:** Send the information in a text message. Select a contact or enter a wireless phone number or email address, enter any additional information, and then tap **Send**. For more information on text messaging, see [Send a Multimedia Message \(MMS\)](#).
- **Samsung Notes:** Save the information in Samsung Notes.
- **Wi-Fi Direct:** Send the information to another device using Wi-Fi Direct. See [Wi-Fi Direct](#).

6. Complete the required steps as prompted for the selected method.

❖ The selected contact will be shared.

Profile Sharing

Share your profile information with your contacts. You can select which contacts you want to share it with, as well as select additional information you want to share.

1. From home, tap **Apps**  > **Contacts** .

❖ You will see the Contacts list.

2. Tap your profile under **Set my profile**.

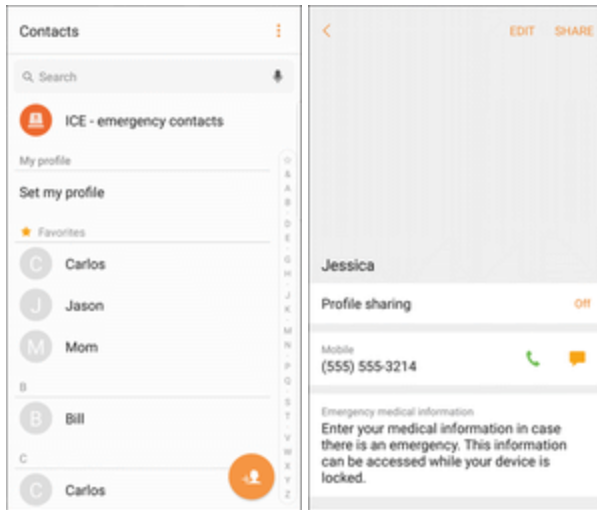

❖ Your profile displays.

3. Tap **Profile sharing**, and then tap **On/Off** to enable the feature.

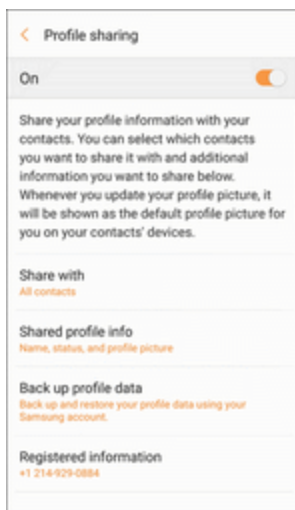

4. Set Profile sharing options:

- **Share with:** Share your profile with the public, all contacts, your favorite contacts, or selected contacts.
- **Shared profile info:** In addition to your name, status, and profile picture, you can share your email, organization, address, and date of birth.
- **Back up profile data:** Back up and restore your profile using your Samsung account.
- **Registered information:** View and set the registered information for your phone number.

Note: The first time you turn on Profile sharing, you may be prompted to agree to the Enhanced features Terms and Conditions and Privacy Policy. Review the terms and tap **Agree** to continue.

Import Contacts

Your phone offers a couple of options for importing contacts from installed SD memory cards or external devices using USB.

Before Importing Contacts from an SD Card

You will need to have installed an SD card with previously backed up contacts information into your phone before you can import contacts. See [SD Card](#) for SD card information.

Import Contacts from an SD Card or USB Storage

1. From home, tap **Apps**  > **Contacts** .

❖ You will see the Contacts list.

2. Tap **More options**  > **Settings** > **Import/export contacts**.

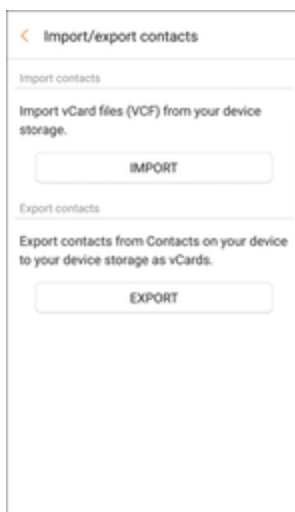

❖ You will see the Import/Export contacts menu.

3. Tap **Import** and follow the prompts to complete the import.

❖ The contacts are imported and stored in the selected account.

Back Up Contacts

If you are saving contacts to an account that does not automatically back them up to the Cloud, you can manually back them up to an optional installed SD card for re-import if needed.

Before Backing Up Contacts to an SD Card

You will need to have installed an SD card (not included) into your phone before you can back up your contacts. See [SD Card](#) for SD card information.

Back Up Contacts to Your SD Card

1. From home, tap **Apps**  > **Contacts** .

❖ You will see the Contacts list.

2. Tap **More options**  > **Settings** > **Import/export contacts**.

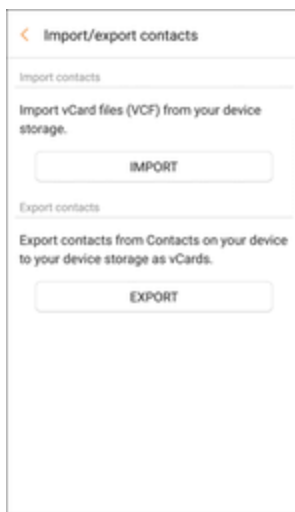

❖ You will see the Import/Export contacts menu.

3. Tap **Export** and follow the prompts to complete the export.

❖ The contacts are exported and saved to the installed SD card.

Contacts Settings

Configure options for contacts stored on your phone.

1. From home, tap **Apps**  > **Contacts** .

❖ You will see the Contacts list.

2. Tap **More options**  > **Settings** > to configure options:

- **Import/Export contacts:** Import contacts from an installed SD memory card and export contacts to an installed SD memory card (not included)

- **Merge duplicated contacts:** Combine duplicate contacts.
- **Contacts to display:** Choose contacts to display in Contacts. You can choose only contacts from your phone's memory, or from an account, or choose other sources. You can also create a customized list of contacts to display.
- **Sort by:** Choose how contacts are sorted, by first or last name.
- **Name format:** Choose how contacts are displayed, by first or last name.
- **Search for nearby places:** Find phone numbers and information for local businesses and venues.
- **Share multiple contacts:** You can choose how to transfer contacts, when sharing them with other devices, such as using Bluetooth.
 - **As one file:** Multiple contacts are sent together. This method can be faster, but depends on whether the target device can accept multiple name cards. If not, only one contact will be sent.
 - **Individually:** Name cards are sent individually. This method may take longer, because the other device must accept each name card individually, but it helps ensure that no name cards are missed.

Messaging

With wireless service and your phone's messaging capabilities, you have the opportunity to share information through many different channels and accounts, including Gmail (Google), personal and corporate email, and text and multimedia messaging.

Text and Multimedia Messaging





With text messaging (SMS), you can send and receive instant text messages between your wireless phone and another messaging-ready phone.

Multimedia messages, or MMS, can contain text and pictures, recorded voice, audio or video files, picture slideshows, contact cards (vCard), or appointments (vCalendar).

See your service plan for applicable charges for messaging.

Send a Text Message

Quickly compose and send text messages on your phone.



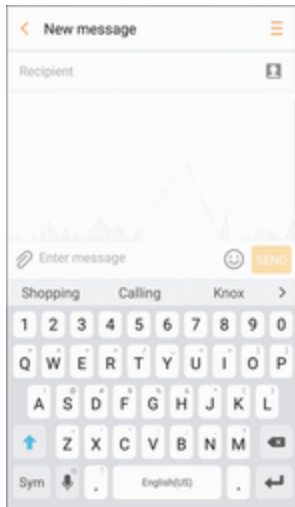

1. From home, tap **Apps**  > **Messages** .
2. On the Messaging screen, tap **Compose new message** .
3. Fill in one or more recipients. You can:
 - Enter phone numbers directly in the **Recipient** field. If you are sending the message to several phone numbers, separate the phone numbers with a comma. As you enter information, any matching phone numbers from your contacts list are displayed. Tap a match to enter that number or address directly.
 - Tap **Add from Contacts** , and then select the contacts to whom you want to send the message. You can also select contact groups as recipients. When you have selected all the message recipients, tap **Done**.
4. Tap the **Enter message** field and then start composing your message.





5. When done, tap **Send**  to send the text message.

Send a Multimedia Message (MMS)

When you need to add a little more to a text message, you can send a multimedia message (MMS) with pictures, voice recordings, audio or video files, contact cards (vCard), or appointments (vCalendar).

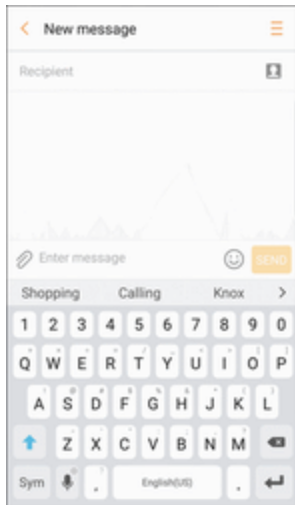







1. From home, tap **Apps**  > **Messages** .
2. On the Messaging screen, tap **Compose new message** .
 - ❖ The Compose screen opens.
3. Fill in one or more recipients. You can:
 - Enter phone numbers directly in the **Recipient** field. If you are sending the message to several phone numbers, separate the phone numbers with a comma. As you enter information, any matching phone numbers from your contacts list are displayed. Tap a match to enter that number or address directly.
 - Tap **Add from Contacts** , and then select the contacts to whom you want to send the message. You can also select contact groups as recipients. When you have selected all the message recipients, tap **Done**.
4. Tap the **Enter message** field, and then start composing your message.



5. Tap **Attach** .
6. In the Attach window, select from the following file attachments:
 - **Camera**: Take a new picture.
 - **Gallery**: Attach a picture from the Gallery app.
 - **Other**: Select from the following sources:
 - **Image**: Attach a stored picture. See [View Pictures and Videos Using Gallery](#).
 - **Video**: Attach a stored video. See [Record Videos](#).
 - **Audio**: Attach a stored music file or voice recording.
 - **Record audio**: Make a voice recording and attach it.
 - **Samsung Notes**: Attach a note. See [Samsung Notes](#).
 - **Calendar**: Select the calendar event you want to attach. See [Calendar](#).
 - **Location**: Add your current location (requires GPS to be turned on) or a location you pick on a map to your message. See [Google Maps](#).
 - **Contacts**: Select a contact from your phone, and then select which contact information you want to attach. See [Contacts](#).
7. Tap **Send**  to send the MMS message.

Create a Slideshow

In a multimedia message, you can add slides, each containing a picture, video, or audio.



1. In the multimedia message you are composing, tap **More options**  > **Create slideshow** to add space for a new slide.
2. Tap the space for the slide.
3. To compose your slideshow, do any of the following:
 - Add a picture. Tap **Attach**  > **Image** and select a picture.
 - Add a video. Tap **Attach**  > **Video** and select a video. (You cannot add both a picture and a video on the same slide.)
 - Add music or a voice recording. Tap **Attach**  > **Audio** and select a file.
 - Add a new slide. Tap **More options**  > **Add slide**.
 - View the next or previous slide. Tap **up** or **down**.
 - Preview your slideshow. Tap **More options**  > **Preview**.
 - For more options, tap **More options**  and select an option.
4. When you have finished composing the multimedia message, tap **Send** .

Tip: To compose a slide show, you can also simply attach multiple items separately to the MMS message. Tap **Attachment**  and select a file type, location, and file and then repeat it for additional slides. Your phone will automatically compile a slide show.

Save and Resume a Draft Message



While composing a text or multimedia message, tap **Back**  to automatically save your message as a draft.

To resume composing the message:

1. From home, tap **Apps**  > **Messages** .
2. Tap the message to resume editing it.
3. When you finish editing the message, tap **Send** .

New Messages Notification

Depending on your notification settings, the phone will play a ringtone, vibrate, or display the message briefly in the status bar when you receive a new text or multimedia message.

New message  also appears in the notifications area of the status bar to notify you of a new text or multimedia message. The **Messages**  app shortcut (if shown on the home screen) also displays the number of new messages.

- To open the message, pull down the status bar to open the notification panel. Tap the new message to open and read it. For more information on reading and replying to messages see [Manage Message Conversations](#).

Manage Message Conversations

Text and multimedia messages that are sent to and received from a contact (or a number) are grouped into conversations or message threads in the Messaging screen. Text or MMS conversations let you see exchanged messages (similar to a chat program) with a contact on the screen.

Read a Text Message



- Do one of the following:
 - On the Messaging screen, tap the text message or conversation to open and read it.
 - If you have a new message notification, pull down the status bar to open the notification panel. Tap the new message to open and read it.

To return to the Messaging screen from a conversation, tap **Back** .

Note: If a message contains a link to a Web page, tap the message and then tap the link to open it in the Web browser.

Note: If a message contains a phone number, tap the message and then tap the phone number to dial the number or add it to your contacts.



View a Multimedia Message (MMS)

1. From home, tap **Apps**  > **Messages** .
2. On the Messaging screen, tap a multimedia message or conversation to open it.
3. Tap the attachment to open it.
 - If the attachment is a vCard contact, it is imported to your phone's contacts list. For more information, see [Contacts](#).
 - If the attachment is a vCalendar file, you can choose the calendar where you want to save the event. For information on using Calendar, see [Calendar](#).
4. To save the attachment to device memory or an SD card, touch and hold the attachment, and then tap **Save attachment** on the options menu.

Note: When Auto retrieve in MMS settings is disabled, only the message header is downloaded. To download the entire message, tap the **Download** button at the right side of the message.

Note: If you are concerned about the size of your data downloads, check the multimedia message size before you download it.



Reply to a Message

1. From home, tap **Apps**  > **Messages** .
2. On the Messaging screen, tap a conversation to open it.
3. Tap the text box at the bottom of the screen, enter your reply message, and then tap **Send** .



Note: To reply to a text message with a multimedia message, open the text message, tap **More** and then tap **More > Add subject**, or **Attach**. The text message is automatically converted into a multimedia message.

Protect (Lock) a Message

You can lock a message so that it will not be deleted even if you delete the other messages in the conversation.

1. From home, tap **Apps**  > **Messages** .
2. On the Messaging screen, tap a conversation.
3. Touch and hold the message that you want to lock.
4. Tap **Lock** on the options menu. A lock icon is displayed at the right hand side of the message.

Delete Conversations

1. From home, tap **Apps**  > **Messages** .
2. On the Messaging screen, tap **More options**  > **Delete**.
3. Select the conversations you want to delete.
4. Tap **Delete** and then tap **Delete** to confirm. Any locked messages will not be deleted.

Tip: You can also delete a conversation while you are viewing it. While viewing a conversation, tap **More > Delete**, and then tap **OK** to confirm. Any locked messages in the conversation will not be deleted unless you select the **Delete locked messages** check box.

Delete a Single Message

1. While viewing a conversation, touch and hold the message that you want to delete.



- If the message is locked, tap **Unlock** on the options menu and hold the message to display the options menu again.
2. Tap **Delete** on the options menu.
 3. When prompted to confirm, tap **Delete**.

View Contact Information from a Message

When you have received a message from someone in your stored contacts, you can tap the contact's picture or icon in the conversation to open a menu of options. Depending on the stored contact information, you can view the contact details, place a phone call or send an email message to the contact, and more.

Messages Settings

The messages settings menu lets you control options for your text and MMS messages including message limits, size settings, and notifications.

1. From home, tap **Apps**  > **Messages** .
2. Tap **More options**  > **Settings** to configure settings:
 - **Notifications:** When turned on, notifications for new messages display in the status bar. Tap **On/Off** to turn the setting on, and then configure options:
 - **Notification sound:** Choose a sound to play for new message notifications.
 - **Vibrations:** Choose whether vibration plays along with the sound for new message notifications.
 - **Pop-up display:** Choose whether a new message pops up on the display to notify you.
 - **Preview message:** Show previews of new messages on the status bar and lock screens, and in pop-ups.
 - **Backgrounds:** Choose backgrounds and bubble styles.
 - **Quick responses:** Create and manage text phrases that you can add to messages.
 - **Block messages:** Block messages by filtering based on criteria you set. Tap **Block messages**, and then configure filters:
 - **Block list:** Enter telephone numbers to automatically block.
 - **Blocked phrases:** Enter text phrases to automatically block.
 - **Blocked messages:** View blocked messages.
 - **More settings > Text messages:**

- **Auto combination:** Choose whether long messages that are received in multiple parts are automatically re-assembled to display as a single message.
- **More settings > Multimedia messages:**
 - **Group conversation:** Control how messages to multiple recipients are handled. When enabled, a single message is sent to multiple recipients. When disabled, a separate message is sent to each recipient.
 - **Auto retrieve:** Choose whether message attachment(s) are automatically downloaded when you display a multimedia message. If you disable this option, only the message header displays in the message list, and you will be prompted to download the attachment(s).
 - **Roaming auto retrieve:** Choose whether message attachment(s) are automatically downloaded when your phone is outside its home network.
- **More settings > Delete old messages:** Automatically delete the oldest messages when the maximum number of text (1000) and multimedia (100) messages has been exceeded.
- **More settings > Split view:** Turn on split view in landscape mode.
- **Emergency alert settings:** Configure emergency alert settings. You can enable or disable some alerts: Extreme Alert, Severe Alert, Amber Alert, and Emergency alert test messages. You cannot disable Presidential alerts.
 - **Emergency alerts:** Choose types of messages to receive. You can enable or display any of the message types, except for Presidential Alert. You can also choose to receive emergency alert test messages.

Important: The Commercial Mobile Alert System (CMAS) system provides the government the ability to send geographically targeted notifications of emergencies, such as threats to public safety, severe weather events, a hazardous material spill or a missing child in the phone user's area.

- **Emergency notification preview:** Play a sample emergency alert tone. Tap **Stop** to cancel the playback.
- **Vibrations:** Select vibration options for emergency message notifications.
- **Alert reminder:** Configure the reminder interval.

Gmail





Use Google's Gmail service and your Google Account to send, receive, and manage your Gmail messages. Before using Gmail, you must register a Google (Gmail) Account on your phone. See [Google Account](#) for details.

Gmail Cautions

Gmail is handled as email from a PC. Restricting email from PCs on your phone prevents your phone from receiving Gmail.

Create and Send a Gmail Message



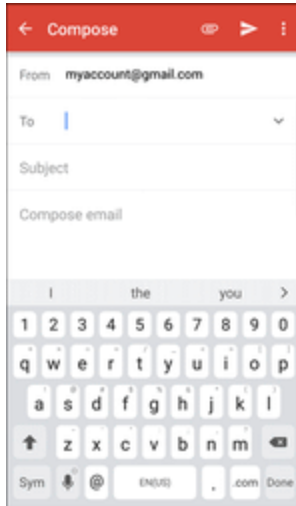

Use your phone to create and send Gmail messages.

1. From home, tap **Apps**  > **Google**  > **Gmail** .
- ❖ The Gmail Inbox opens.
2. In the Inbox, tap **Compose** .
- ❖ The Gmail composition window opens.
3. Enter the message recipient(s), subject, and message, and then tap **Send** .



- ❖ The Gmail message is sent.

Gmail Composition Options

- **Adding Cc/Bcc:** In the mail composition window, tap **Expand** , and then add recipients.
- **Attaching Pictures or Videos:** In the mail composition window, tap **Attach**  > **Attach file** or **Insert from Drive**. Locate and then tap the picture or video you want to attach.
- **Save as a Draft (Send Later):** While composing your message, tap **More options**  > **Save draft**. The message is saved as a draft for later.
- **Delete Mail Being Composed:** In the mail composition window, tap **More options**  > **Discard** > **Discard**.

Note: To view your draft email messages, in the Inbox, tap **Menu**  > **Drafts**.

Note: To view your sent messages, in the Inbox, tap **Menu**  > **Sent**.

Check Received Gmail Messages

Your phone allows you to access, read, and reply to all your Gmail messages.

Open Gmail Messages from Notifications

When new Gmail arrives, you will see **New Gmail**  in the status bar.

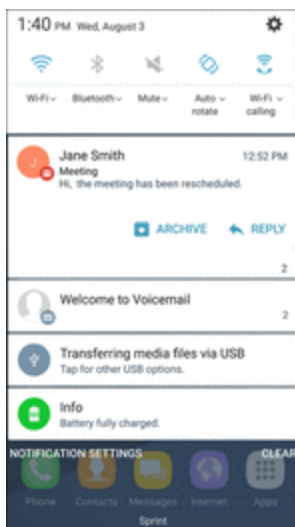

1. Pull down the status bar to display the notification panel.
2. Tap the new message from the notification panel.



- ❖ The new Gmail message opens.
 - If you have two or more new Gmail messages, tapping the notification opens the Gmail Inbox.

Open Gmail Messages from the Inbox



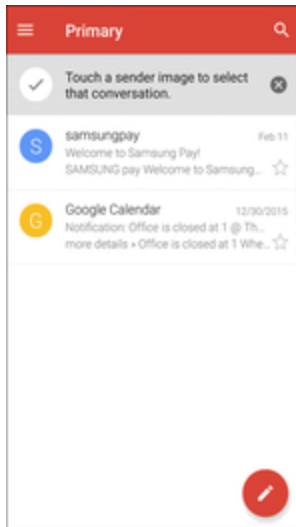

You can also read and reply to all your Gmail messages from the Gmail Inbox.

1. From home, tap **Apps**  > **Google**  > **Gmail** .
- ❖ The Gmail Inbox opens.
2. Tap the message thread you want to view.



❖ The message thread opens, with the newest message displayed.

Options when Reviewing Gmail Messages

- **Replying to Gmail Messages:** With the Gmail message open, tap **Reply** , compose your reply message, and tap **Send** .
 - To reply to all, tap **More options**  > **Reply all**.
- **Forwarding Gmail Messages:** With the Gmail message open, tap **More options**  > **Forward**, enter a recipient and an additional message, and tap **Send** .

Use Gmail Labels

Gmail saves all mail in one box, but you can add labels that allow you to sort your Gmail conversation threads. For example, when a new thread starts with a received mail, the label “Inbox” is automatically added to the thread. By then adding the label “travel,” all threads with “travel” are shown in a list.

1. From home, tap **Apps**  > **Google**  > **Gmail** .

❖ The Inbox opens.

2. Touch and hold a conversation thread to add a checkmark to it, and then tap **More options**  > **Move to**.

3. Tap a label for the thread.

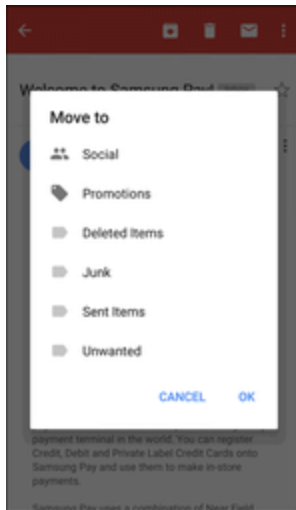

- ❖ The thread is added to the selected label.

Archive Gmail Threads

Remove sent and received Gmail threads so they do not appear in the Inbox. When replies arrive for archived threads, they appear in the Inbox again.

1. From home, tap **Apps**  > **Google**  > **Gmail** .

- ❖ The Inbox opens.

2. Touch and hold a conversation thread to add a checkmark to it, and then tap **Archive** .

- ❖ The thread is now archived.

Mute Gmail Threads

If registered on a mailing list, there will be threads with always-continuing conversations. For long threads that are not important, mute the threads and they will no longer appear in the Inbox. When mail arrives that includes user's address as a recipient or in Cc, mail will again appear in the Inbox.

1. From home, tap **Apps**  > **Google**  > **Gmail** .





- ❖ The Inbox opens.

2. Touch and hold a conversation thread to add a checkmark to it, and then tap **More options**  > **Mute**.

- ❖ The thread is now hidden.





Delete Gmail Threads

If you no longer wish to keep a Gmail conversation thread, you can simply delete it from the Inbox.

1. From home, tap **Apps**  > **Google**  > **Gmail** .
❖ The Inbox opens.
2. Touch and hold a conversation thread to add a checkmark to it, and then tap **Delete**  > **OK**.
❖ The thread is deleted.





Search Gmail Messages

If you need to find a specific message or message thread, you can search Gmail from the Inbox.

1. From home, tap **Apps**  > **Google**  > **Gmail** .
❖ The Inbox opens.
2. Tap **Search** .
3. Enter your search text and tap **Search** .
❖ The search results appear. Tap a message or thread from the list to display it.



Report Spam Gmail Messages

You can report spam Gmail messages from your phone's Gmail Inbox.

1. From home, tap **Apps**  > **Google**  > **Gmail** .
❖ The Inbox opens.
2. Touch and hold a conversation thread to add a checkmark to it, and then tap **More options**  > **Report spam**.
❖ The selected message is reported as spam Gmail.

Add Another Google (Gmail) Account

If you have multiple Gmail accounts you wish to view on your phone, you can add them from the **Settings** > **Clouds and accounts** > **Accounts** menu.

1. From home, tap **Apps**  > **Settings**  > **Cloud and accounts**  > **Accounts** > **Add account**.
2. Tap **Google**, and then tap **Enter your email**.

3. Enter your Gmail username and password, and then tap **Next**.
4. After your phone connects with the Google servers, select the items you would like to sync with your phone and then tap **Sync now**.
5. Tap **Finish setup**.

❖ You are signed in to your Google Account, and you can access both of your Gmail accounts from the Gmail app.

Note: You can also sign up for a new Gmail account from the Settings menu. In step 2 above, tap **Or create a new account** and follow the prompts.

Switching Between Gmail Accounts

If you have more than one Gmail account set up, you can switch between them in the Gmail app.

1. From home, tap **Apps**  > **Google**  > **Gmail** .

❖ The Inbox opens.

2. Tap **Menu** .

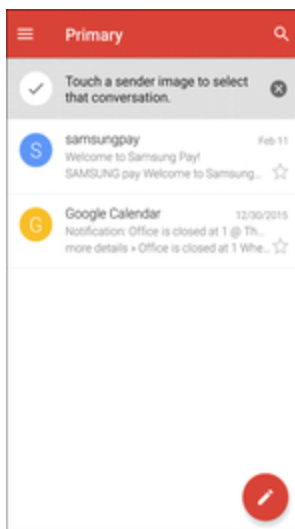

3. Tap the icon for the account you want to view from the list at the top of the menu.

❖ The selected account Inbox is displayed.

Gmail Settings

You can access settings for the Gmail app and for your individual Gmail accounts from the Gmail Settings menu.

1. From home, tap **Apps**  > **Google**  > **Gmail** .

❖ The Primary Inbox opens.

2. Tap **Menu**  > **Settings** .

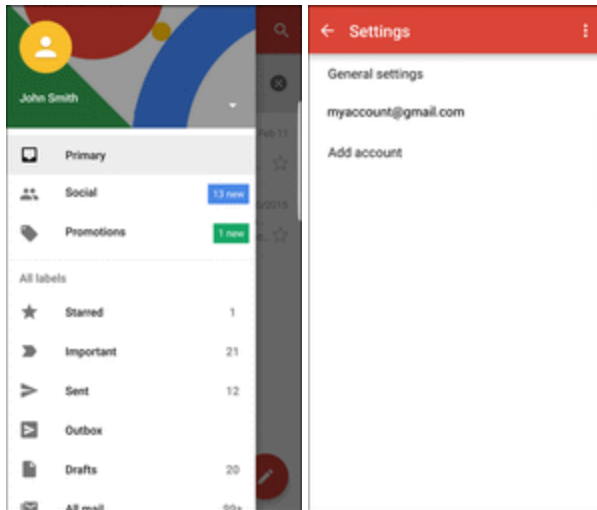

3. Tap **General settings** to access settings for all accounts, or tap an **account name** to configure settings for a specific Gmail account.

- **General settings:** Gmail default action, Conversation view, Swipe actions, Sender image, Reply all, Auto-fit messages, Auto advance, Confirm before deleting, Confirm before archiving, and Confirm before sending.
- **Account settings:** Inbox type, Inbox categories, Notifications, Inbox sound & vibrate, Signature, Vacation responder, Sync Gmail, Days of mail to sync, Manage labels, Download attachments, and Images.

Note: Available settings are subject to change.

Email

Use the Email application to send and receive email from your webmail or other accounts, using POP3 or IMAP, or access your ActiveSync account for your corporate email needs.

Set Up an Email Account

Your phone supports several types of email accounts and allows you to have multiple email accounts set up at one time.

Before setting up an email account, make sure you have the username (user ID), password, server name, etc., so you can get set up successfully.

1. From home, tap **Apps**  > **Samsung**  > **Email** .

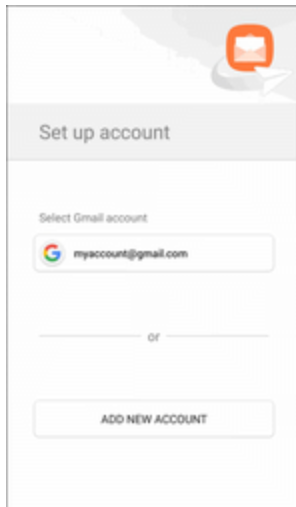





- ❖ A popup window for adding an account appears if no email account has been previously set up.
- 2. Tap a configured Gmail account to use it with the Email app, or tap **Add new account** to add a different email account.
- 3. Follow the prompts to set up your email account.
- ❖ The email account is set up and you will begin receiving email.

Add an Email Account



You can add several types of personal email accounts, such as POP3 and IMAP accounts, on your phone.

Add an Email Account from the Email App

You can add email accounts directly from the email app, even if you have another email account set up.

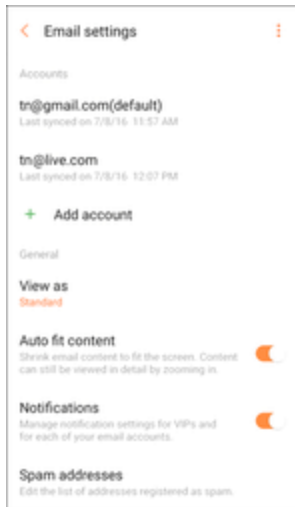

1. From home, tap **Apps**  > **Samsung**  > **Email** .
- ❖ The email Inbox opens.
2. Tap  **Menu options** > **Settings**.



3. Tap **Add account** .
4. Follow the prompts to complete the account setup.
 -  The email account is added and you will begin receiving email for the account.

Add an Email Account from the Settings Menu

You can also set up email accounts from the **Settings > Clouds and accounts** menu.

1. From home, tap **Apps**  > **Settings**  > **Cloud and accounts**  > **Accounts > Add account > Email**.
2. Enter the **Email address** and **Password** for the email account and then tap **Sign in**.

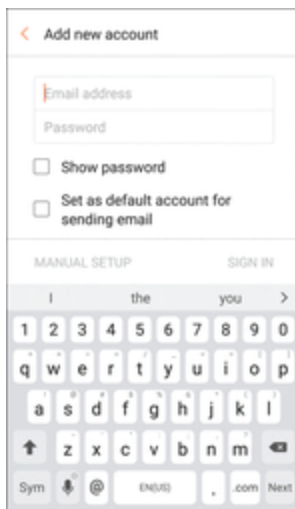

-  Tapping **Sign in** prompts your phone to attempt a “regular” email setup and test the incoming and outgoing servers.



- If you have custom settings you need to configure, tap **Manual setup** and enter your settings. These may include mail type, user name, password, server, security type, etc.
3. Select your sync settings and then tap **Next**.
 4. Enter an account name and a display name and tap **Done** to complete setup.
 - ❖ The email account is set up and you will begin receiving email for the account.

Important: If the account type you want to set up is not in the phone database, you will be asked to enter more details. You should get all pertinent information for the email account, such as incoming and outgoing server settings, before you proceed.

Add an Exchange ActiveSync Account

If you synchronize your phone with your Exchange ActiveSync account, you can read, manage, and send email in the same easy way as with a POP3/IMAP account. However, you can also access some powerful Exchange features.

Important: Before setting up a Microsoft® Exchange ActiveSync Account, contact your company's Exchange Server administrator for required account settings information.

1. From home, tap **Apps**  > **Settings**  > **Cloud and accounts**  > **Accounts** > **Add account** > **Microsoft Exchange ActiveSync**.
2. Enter the **Email address** and **Password** for the email account and then tap **Manual setup**.
3. Enter the required information:
 - **Domain\username:** Enter your network domain and username, separated by “\”.
 - **Password:** Enter your network access password (case-sensitive).
 - **Exchange server:** Enter your system's Exchange server remote email address. Obtain this information from your company network administrator.
 - **Use secure connection (SSL):** Tap to place a checkmark in the box, if your system requires SSL encryption.
 - **Use client certificate:** Tap to place a checkmark in the box, if your system requires certification.
4. Follow the prompts to configure options for the account.
5. Enter an account name and a display name and tap **Done** to complete setup.
 - ❖ Your corporate email account is set up and you will begin receiving email for the account.

Create and Send an Email Message

Compose and send email using any account you have set up on your phone. Increase your productivity by attaching files such as pictures, videos, or documents to your email messages.

1. From home, tap **Apps**  > **Samsung**  > **Email** .

❖ The email Inbox opens.

- If you want to switch to a different email account, tap the account name at the top of the screen and select another account.

2. Tap **Compose new email** .

❖ The email composition window opens.

3. Enter the message recipient(s).

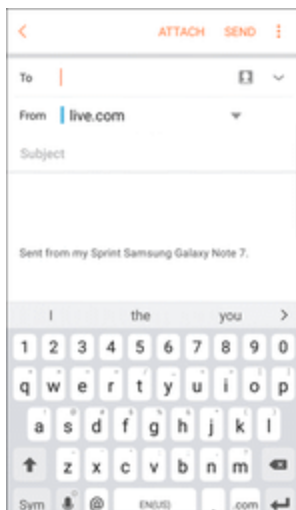

- You can add multiple recipients to an email message.
- To add recipients from Contacts, tap **Add from Contacts** , select the contact(s) you wish to include, and then tap **Done**.

4. Enter the email subject and message.

- To add an attachment to the message, tap **Attach**, select an attachment type and an attachment, and then tap **Done**.

5. Tap **Send**.

❖ The email message is sent.

Open Email Messages

You can open and read email messages directly from the email Inbox. Reading and replying to email on your phone is as simple as on your computer.

1. From home, tap **Apps**  > **Samsung**  > **Email** .

❖ The email Inbox opens.

2. Tap the message you want to view.

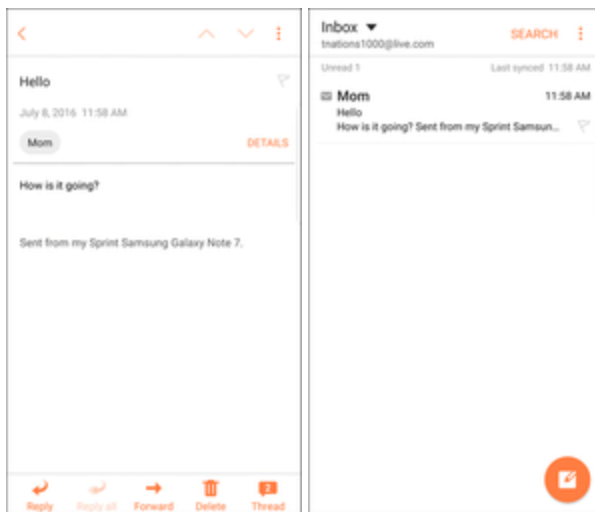

❖ The email message opens.

3. Tap **Reply**  or **Reply all**  to reply to the message.

Tip: Tap the account name at the top of the screen to switch to a different email account.

Tip: You can also access new email messages from the notification panel. Pull down the status bar to display the notification panel, and then tap an email notification. The email Inbox will open and display the new email message.

Options when Reviewing Email Messages

- **Resetting Mail as Unread:** Touch and hold a message to select it, and then tap **More > Mark as unread**.
- **Deleting Email:** Touch and hold a message to select it, tap the check box on the left side of any other messages, and then tap **Delete** .
- **Syncing Accounts Manually:** Sync sent and received email messages manually at any time regardless of the automatic sync settings. Switch to the account you want to sync, and then swipe down.

- **Replying to Email Messages:** With an email message open, tap **Reply** ↩️ or **Reply all** ↩️↩️, compose your reply message, and tap **Send**.
- **Forwarding Email Messages:** With the email message open, tap **Forward** ➡️, enter a recipient and an additional message, and tap **Send**.

Delete an Email Account

You can delete an email account from your phone if you no longer wish to receive messages for the account on your phone.

1. From home, tap **Apps** 🗄️ > **Samsung** 📱 > **Email** 📧.

❖ The email Inbox opens.

2. Tap **More options** ⋮ > **Settings**.

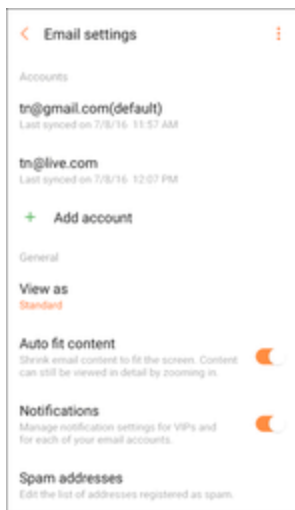

3. Tap an account name, and then tap **Remove** > **Remove**.

❖ The account is deleted from your phone

Manage Your Email Inbox

Your email Inbox provides management options for viewing, sorting, and deleting your email messages.

View Your Email Inbox

1. From home, tap **Apps** 🗄️ > **Samsung** 📱 > **Email** 📧.

❖ The email Inbox opens.

2. Tap the email account at the top of the screen to select a different Inbox, or tap **Combined inbox** to see all your email Inboxes at once.

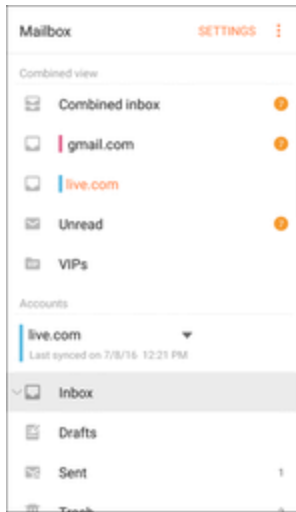

Refresh an Email Account

Whatever your automatic synchronization settings are, you can also synchronize your sent and received email messages manually at any time.

- While viewing the account you want to synchronize, swipe down.

Sort Email Messages

1. On the email account Inbox, tap **More options**  > **Sort by**.
2. Select from the options to sort email messages by date received, sender, read/unread, attachments, or priority.

Delete Email Messages





1. On the email account Inbox, touch and hold the message you want to delete.
 - Tap check boxes to select additional emails to delete.
2. Tap **Delete**.

Note: Depending on your settings, you may be prompted to confirm the deletion by tapping **Delete**. See [Email Settings](#).

Exchange ActiveSync Email Features

Set options for your corporate Exchange ActiveSync email messages, including synchronization options, flagging messages, out-of-office messages, meeting requests, and message priority.

To access Exchange ActiveSync settings:

1. From home, tap **Apps**  > **Samsung**  > **Email** .
2. Tap **More options**  > **Settings**.
3. Tap the Exchange ActiveSync account name to view its options.
 - The following options are available:
 - **Sync account:** Keep the account synchronized on your phone.
 - **Account name:** Change the account name.
 - **Your name:** Enter your name.
 - **Always Cc/Bcc myself:** Send a copy of each email you send to yourself.
 - **Signature:** Enable and configure your signature for each email you send.
 - **Show images:** Show all images in emails.
 - **Auto download attachments:** Automatically download attachments when connected to a Wi-Fi network.
 - **Sync schedule:** Configure a schedule for syncing your email account.
 - **Period to sync Email:** Configure how far back in time you want to sync your email account.
 - **Limit retrieval size:** Set a limit to the size of email messages you want to receive on your phone.
 - **Limit retrieval size while roaming:** Set a different email size limit when your phone is on roaming.
 - **Out of office settings:** You can set your Out of Office status and auto-reply message right from your phone.
 - **Folder sync settings:** Select which email folders to sync with the server.
 - **Period to sync Calendar:** Set the time period for syncing your calendar with the server.
 - **Empty server trash:** Delete the content of the trash folder on the server.
 - **In case of sync conflict:** Select whether the device or the server has priority during a sync conflict.
 - **Sync Contacts:** Sync your Contacts with your Exchange account.
 - **Sync Calendar:** Sync your calendar with your Exchange account.
 - **Sync Task:** Sync your tasks with your Exchange account.
 - **Sync Messages:** Sync your messages with your Exchange account.

- **Security options:** Manage encryption and signature options for outgoing email.
- **Exchange server settings:** Modify the Exchange server settings for this email account.

Email Settings

Configure options for email accounts you set up on your phone.

General Email Preferences

1. From home, tap **Apps**  > **Samsung**  > **Email** .

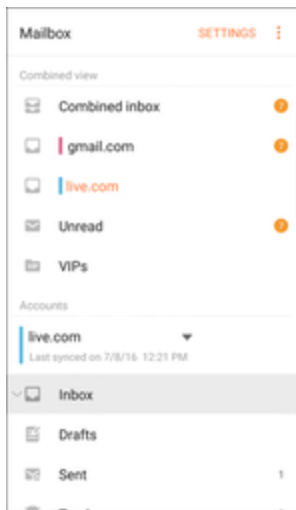

2. Tap **More options**  > **Settings** to configure options. General email settings, which affect all email accounts, include:
 - **Manage accounts:** Configure options for specific accounts. Available settings depend on the type of account.
 - **Add account:** Add additional email accounts.
 - **View as:** View emails in standard or conversational mode.
 - **Auto fit content:** Shrink email content to fit the screen. Content can still be viewed in detail by zooming in.
 - **Notifications:** Notifications for new emails display in the status bar. When disabled, you can control notifications for each of your email accounts individually in the account's settings.
 - **Spam addresses:** Create and maintain a list of email addresses and domains to automatically block emails from those senders.
 - **Split view mode:** Turn on split view on landscape screen.
 - **Confirm deletions:** Ask for confirmation before deleting email.

Manage Email Account Settings

You can edit settings for your individual email accounts, such as email address and password, name display and signature, frequency of retrieval, and more.

Note: Available settings depend on the type of email account.

1. From home, tap **Apps**  > **Samsung**  > **Email** .

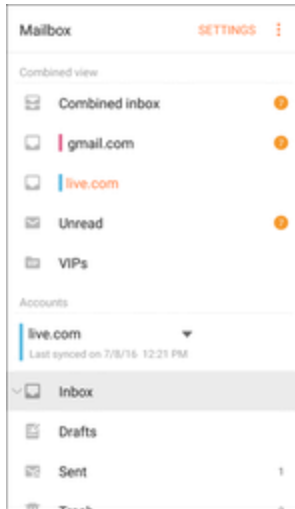

2. Tap **More options**  > **Settings**, and then tap an account to set its options. Individual email account settings may vary; see your service provider for details. Common settings include:
 - **Sync account:** Configure options for synchronizing your phone with your account.
 - **Account name:** Enter a name to identify this email account.
 - **Always Cc/Bcc myself:** Choose options for sending a copy of emails you send to yourself, as a copy (Cc) or blind copy (Bcc).
 - **Signature:** Customize or delete the text signature that is automatically added to emails you send.
 - **Show images:** Choose whether to automatically display embedded images in the body of an email.
 - **Auto download attachments:** Choose whether the phone automatically downloads email attachments when you are connected to Wi-Fi. You might use this option to control how and whether you use your plan's data services to download attachments.
 - **Sync schedule:** Set a sync schedule for email, such as choosing different sync options for peak days or times, or when roaming.

- **Period to sync Email:** Choose the period for synchronizing email between your phone and account.
- **Limit retrieval size:** Choose the email retrieval size for each message.
- **Limit retrieval size while roaming:** Choose the email retrieval size while roaming.
- **Out of office settings:** Configure options for automatically sending replies when you are out of the office.
- **Folder sync settings:** Choose which folders to sync.
- **Period to sync Calendar:** Choose the period for synchronizing calendar events between your phone and account.
- **Empty server trash:** Delete the contents of the trash folder on the account server.
- **In case of sync conflict:** Choose whether information from the server or phone has priority when there is a conflict.
- **Sync Contacts:** Choose whether contacts are synchronized between your phone and the account.
- **Sync Calendar:** Choose whether calendar events are synchronized between your phone and the account.
- **Sync Task:** Choose whether tasks are synchronized between your phone and the account.
- **Sync Messages:** Choose whether messages are synchronized between your phone and the account.
- **Security options:** Manage encryption and signature options for outgoing mail.
- **Exchange server settings:** Configure the Domain\user name, Password, and other Exchange server settings.

Internet and Social Networking

The following topics describe how to connect to and use the Internet on your phone, and how to access popular social networking sites such as Facebook, Twitter, Hangouts, LinkedIn, and more.

Data Services General Information (4G LTE and 3G Networks)

The following topics will help you learn the basics of using your data services, including managing your user name, launching a data connection, and navigating the Web with your phone.

Important: Certain data services requests may require additional time to process. While your phone is loading the requested service, the touchscreen or QWERTY keyboard may appear unresponsive when in fact they are functioning properly. Allow the phone some time to process your data usage request.



4G LTE

The Sprint 4G LTE network provides your phone with wireless Internet access over greater distances than Wi-Fi and delivers data transfer rates of up to 60 Mbps. To connect your phone to the 4G LTE network, you must be in an area covered by the 4G LTE network.

For more information about the availability of Sprint 4G LTE service in your location, visit sprint.com/coverage.

Note: The availability and range of the network depends on a number of factors including your distance to the base station, and infrastructure and other objects through which the signal passes.

Set Your Network Options

1. From home, tap **Apps**  > **Settings**  > **Connections**  > **Mobile networks** > **Network mode**.
2. Select **CDMA, LTE / CDMA, GSM / UMTS**, or **Automatic**.
 - ❖ The phone will scan for the best available Sprint network and will automatically connect to it.

When your phone is connected using 4G LTE, **LTE**  appears above the signal strength indicator in the status bar.

Note: The Sprint networks are self-discoverable, which means no additional steps are required for your phone to connect to them.

Your User Name

When you buy your phone and sign up for service, you are automatically assigned a user name, which is typically based on your name and a number, followed by “@sprintpcs.com.” (For example, the third John Smith to sign up for Sprint data services might have jsmith003@sprintpcs.com as his user name.)

When you use data services, your user name is submitted to identify you to the network. Your user name is automatically programmed into your phone. You do not have to enter it.

Find Your User Name

You can find your user name through your phone's device menu.

1. From home, tap **Apps**  > **Settings**  > **About device** .
2. Tap **Status**.



- ❖ You will see your user name under the “Username” heading.

Update Your User Name

If you choose to change your user name and select a new one online, or make any changes to your services, you must then update the profile on your phone.

1. From home, tap **Apps**  > **Settings**  > **System Update** .

2. Tap **Update Profile**.

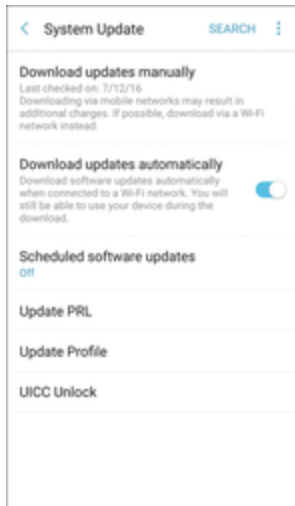

❖ Your phone will download and install the profile update.

Data Connection Status and Indicators

Your phone displays the current status of your data connection through indicators at the top of the screen. The following symbols are used:

Icon	Status
	Network (full signal): The fullness of the triangle icon indicates the strength of the signal. A fuller icon means a better signal.
	4G LTE data service: Your phone is connected to a 4G LTE network.
	3G (data service): Your phone is connected to a 3G network.

Browser

Browse the Internet using a full-featured browser.

SSL/TLS

SSL (Secure Sockets Layer) and TLS (Transport Layer Security) are protocols for encrypting sent/received data. While in a screen connected by SSL/TLS, data is encrypted to safely send/receive private information, credit card numbers, corporate secrets, etc., and provide protection against online threats (eavesdropping, falsification, impersonation, etc.).

SSL/TLS Cautions

When opening a secured page, users must decide as their responsibility whether or not to open the page with use of SSL/TLS. Sprint and the applicable Certification Authorities make no guarantees whatsoever to users regarding security of SSL/TLS.

Use the Browser

Launching the browser is as easy as tapping an icon.

- From home, tap **Apps**  > **Samsung**  > **Internet** .

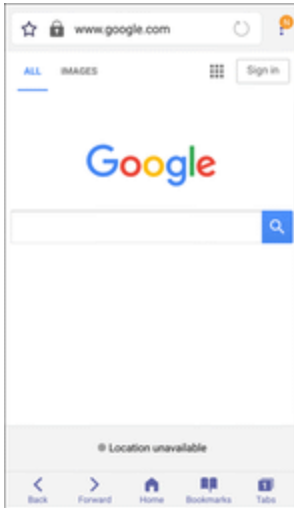

- ❖ The browser opens.
 - The first time you launch Internet, you may be prompted to enter your 10-digit wireless phone number to access the Sprint home page.
 - You can also launch the browser by tapping a URL in a text message, email message, or Gmail message.

Browser Use Options

- **Searching within a Web Page:** With a Web page displayed, tap **More options**  > **Find on page**, and enter your search text.

Tip: To change the phone's default launch page to your current page, tap **More options**  > **Settings** > **General** > **Homepage** > **Current page**.

Add a Bookmark

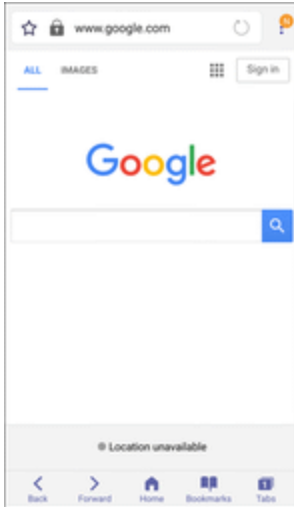

Bookmark favorite sites using the browser menu options.

1. From home, tap **Apps**  > **Samsung**  > **Internet** .



- ❖ The browser opens.
- 2. Navigate to the Web page you want to bookmark, and tap **Bookmarks**  > **Add**.
- ❖ The add bookmark window opens.
- 3. Check or change the bookmark title, URL, etc., and then tap **Save**.
- ❖ The Web page is added to bookmarks.

Bookmark Options

- **Editing Bookmarks:** From the browser, tap **Bookmarks** , touch and hold a bookmark, tap **More** > **Edit bookmark**, edit the bookmark, and then tap **OK**.
- **Deleting Bookmarks:** From the browser, tap **Bookmarks** , touch and hold a bookmark, and then tap **Delete**.
- **Show Saved Web Pages:** From the browser, tap **Bookmarks**  > **Saved pages**, and then tap a saved page to open it.

View Browser History

Use the browser menu options to view your browsing history.

1. From home, tap **Apps**  > **Samsung**  > **Internet** .

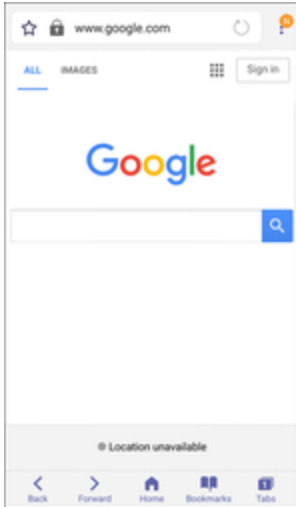

❖ The browser opens.

2. Tap **Bookmarks** .

❖ The bookmark window opens.

- If you do not see **Bookmarks** , pull down the Web page to display the address bar.

3. Tap the **History** tab, and then tap an entry.

❖ The Web page opens.

Open New Browser Tabs

Use tabbed browsing to switch between websites quickly and easily.

1. From home, tap **Apps**  > **Samsung**  > **Internet** .

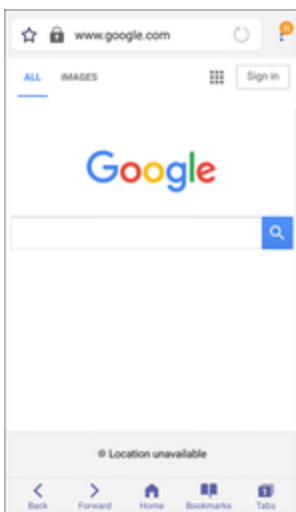

❖ The browser opens.

2. Tap **Tabs** .



❖ The tabs window opens.

- If you do not see **Tabs** , drag the Web page down to display the address bar.

3. Tap **New tab**.

❖ A new tab appears.

- To switch tabs, tap one of the available thumbnails in the tabs window.

Browser Settings

1. From home, tap **Apps**  > **Samsung**  > **Internet** .

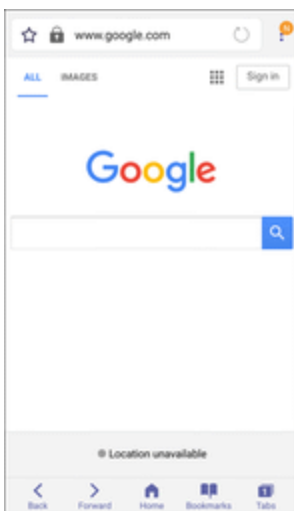

❖ The browser opens.

2. Tap **More options**  > **Settings** to configure options:

- **Homepage:** Choose a homepage to display when you launch Internet.
- **Default search engine:** Choose a default search engine.
- **Auto fill profile:** Manage your Auto fill profile.
- **Manual zoom:** Override website requests to control zoom level.
- **Privacy:** Choose options related to privacy.
- **Advanced:** Choose settings to control how the browser treats content, such as allowing JavaScript, blocking pop-ups, and managing website data.
- **About internet:** View information about the Browser app.

Chrome Browser

Use Chrome™ to browse the Internet and bring your open tabs, bookmarks and address bar data from your computer to your mobile device.

1. From home, tap **Apps**  > **Google**  > **Chrome** .

❖ Chrome opens.

2. Tap the address bar at the top and enter search words (for a Google search) or a Web address (URL).

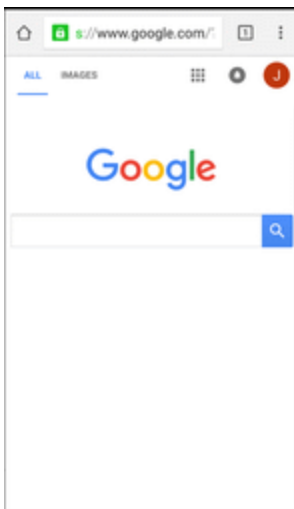

❖ The search results appear or a Web page opens.

Chrome Support

- To find on-phone help with Chrome, from Chrome, tap **More options**  > **Help & Feedback**.
- ❖ A Web page will open displaying Google help for Chrome.

Tip: For more information, from your computer, visit: google.com/intl/en/chrome/browser/mobile

Facebook

Keep up with friends and family with the Facebook app. Share updates, photos, and videos, as well as text, chat, and play games.

Once you have signed in in Facebook, you can post and read updates, upload pictures, tag locations, and more, all from your phone.

1. From home, tap **Apps**  > **Social**  > **Facebook** .

❖ The Facebook app launches.

- If this is the first time you have used Facebook on your phone, enter your Facebook ID and password and tap **Log in** to sign in to an existing account, or tap **Sign Up for Facebook** to set up a new Facebook account.
2. Tap **Status** and type an update, tap **Photo** and upload a picture from the gallery, tap **Check In** to share your location, “Like” and comment on friends’ posts, and more.



Hangouts

Meet friends and family online, share photos, host video calls, and send SMS and Hangouts messages. Log in to a Google Account beforehand (see [Google Account](#)).

Using Hangouts

1. From home, tap **Apps**  > **Google**  > **Hangouts** .



- ❖ The Hangouts app will open.
- 2. Tap **Add**  to start a new Hangout.
- 3. Type a name, email, number, or circle, or select a contact from the list.
- 4. Type a message or tap **Video**  to start a video chat.
- ❖ A chat window or a video chat window opens.
 - Each time text is entered, the corresponding friend appears.
 - If a friend is not in a Hangout, you will see a message. Tap **Send invitation** to invite them to join the Hangout.



Hangouts Operations

- **Ending a Chat:** In the Hangouts window, flick the chat from left to right.
- **Ending a Video Chat:** In the video chat window, tap **End** .
- **Disabling Chat History:** If you do not want to keep chat history, in the chat window, tap **More > Turn history off**.
- **Delete Chat History:** To delete all your chat history, in the chat window, tap **More > Delete > Delete**.

Note: You can use Hangouts as your phone's default messaging app, or as a standalone IM app. If you set Hangouts as the default messaging app, the Messages app will be disabled. For more information, see [Default Applications](#).



Instagram

Capture and share photos and videos with your friends. Customize what you capture, and then share it on your feed or post it directly to your friends.

- From home, tap **Apps**  > **Social**  > **Instagram** .
- The first time you access Instagram™, follow the prompts to sign up for an account, or sign in with Facebook or an existing account.

Messenger

Reach out to your friends and family with Facebook Messenger, which works just like texting. A data plan is required to use Messenger.

1. From home, tap **Apps**  > **Social**  > **Messenger** .
2. Follow the prompts to log in with your Facebook account. See [Facebook](#).

Global Services

With your phone and global roaming service from Sprint WorldwideSM Wireless Service, you can make phone calls and use wireless data services around the globe on compatible CDMA and GSM/UMTS networks. For a country-specific travel guide, select your phone and destination from sprint.com/traveltips.

Activate Sprint Worldwide Service on Your Account

Before using your phone in global roaming mode, you must activate Sprint Worldwide service.

To activate Sprint Worldwide service:

- Chat with or email an international support rep by visiting sprint.com/swwsupport.
- or –
- Call Sprint Worldwide Customer support at 1-888-226-7212.

Your Phone's SIM Card for International GSM Roaming

Your phone comes with a preinstalled SIM (Subscriber Identity Module) card to support roaming on compatible GSM networks.

Note: Your SIM card should be preinstalled. If you need to reinstall your SIM card, follow the instructions below.

Note: The SIM card included with your phone contains information specific to your phone and should be retained for use on GSM networks.

Insert a SIM Card

Caution: Exercise care when using the removal tool to eject the internal SIM card/Memory card tray.

1. Insert the removal tool into the hole on the SIM card/Memory card tray, and push until the tray pops out.

2. Place the SIM card on the tray.



- Make sure that the card's gold contacts face down into the device and that the card is positioned as shown.

3. Slide the SIM card/Memory card tray back into the slot.

Important: To prevent water and dust from entering the device, remove any dust on the gasket and ensure that the SIM card tray is closed tightly.



Caution: If the card is not inserted correctly, the device cannot detect the SIM card. Re-orient the card and place it back into the slot if the SIM is not detected.

Enable Global Roaming Mode

Your phone is designed to enter global roaming mode automatically when you activate your Sprint Worldwide service, meaning that it should automatically connect to an appropriate CDMA/LTE network or GSM/UMTS network when you travel. You may set global roaming options through the settings menu.



You may also need to set your network mode options through the settings menu. See [Set the Communications Method for Global Use](#).

To set your roaming options manually:

1. From home, tap **Apps**  > **Settings**  > **Connections** .
2. Tap **Mobile networks** > **Data roaming**.
3. Tap **Roaming network**.
4. Tap **Home only** or **Automatic**.
 - ❖ The selected roaming method is set.
5. Tap **Roaming guard**.
6. Select roaming guard options for each category.
 - ❖ The selected options are set.

Set the Communications Method for Global Use

Select a communications method for an overseas carrier as needed.



1. From home, tap **Apps**  > **Settings**  > **Connections** .
2. Tap **Mobile networks**.
3. Tap **Network mode** > **CDMA / LTE/CDMA / GSM/UMTS / Automatic**.

❖ The communications method is set.

Note: At the time of purchase, your phone is set to the **Automatic** mode by default. This allows global usage and normally will not need to be changed.

Select a Carrier

You can select a specific local carrier to use when traveling internationally. At the time of purchase, your phone is preset to connect automatically to an appropriate carrier in your current area.

1. From home, tap **Apps**  > **Settings**  > **Connections** .
2. Tap **Mobile networks**.
3. Tap **Network operators**.
4. Tap an available network.

❖ The selected carrier is set.

- To automatically select an appropriate carrier (default), tap **Choose automatically**.
- To search for all available networks, tap **Search networks**.

Make and Receive Worldwide Calls

When traveling on international networks, you can place and answer calls as you would on the Sprint network (see [Place and Answer Calls](#)), although some additional instructions may be required to place a call. Some features and services are not available in all countries. For more information on services that are available while roaming, visit sprint.com/sww.





Make Calls Using Plus (+) Code Dialing

Placing calls from one country to another country is simple with the Plus (+) Code Dialing feature. When placing international calls, you can use Plus Code Dialing to enter the appropriate international access code for your location (for example, 011 for international calls placed from the United States).

Note: Plus Code Dialing is only available when roaming internationally on GSM networks and on certain CDMA networks in the United States, Canada, and the Caribbean.

Note: International access codes and dialing information are available online at sprint.com/sww.

To use Plus Code Dialing to place an international call:

1. From home, tap **Phone**  to display the phone screen.
2. If you are on the GSM network, touch and hold  to insert a “+” on the phone dial screen. (The “+” symbol automatically inserts the international access code for the country from which you are calling.)
3. If you are on the CDMA network outside Canada or the Caribbean, enter the international access code for the country from which you are calling.
4. Tap  to insert the US country code, and then enter the area code and number.
5. Tap  to place the call.

Sprint International Voicemail Service

Your Sprint voicemail will follow you as you travel. All of your unanswered calls will be forwarded to your Sprint voicemail. You will need to be sure your voicemail box is already set up and that you know your voicemail passcode.

Note: Sprint voicemail may not be available on all networks; check sprint.com/sww for service information.



International Voicemail Troubleshooting

There are a few tips to keep in mind when using Sprint voicemail while traveling.

- Some carriers may not support voicemail indicators. It may be necessary to call your voicemail to see if you have any new messages.
- If you hear the message “Please enter the number of the subscriber you wish to call,” enter your 10-digit wireless phone number.

Set Up Your Voicemail Access Number for International Use

To simplify accessing your Sprint Voicemail while traveling, you can set up your voicemail access number as a Contacts entry. This will make it faster and easier to access your messages while roaming internationally.

1. From home, tap **Apps**  > **Contacts** .
 2. Tap **Add**  to add a contact.
 3. Type the contact information (for example, “My Voicemail”).
 4. Touch and hold **0** () , and then tap **1** () (**+1**), your area code, and your wireless phone number.
 5. Tap **Save**.
- ❖ Your voicemail access number is saved as a contact.

Access Your Voicemail Internationally

You will need to call your voicemail number to access your voicemail while roaming internationally.

New Message Indicators



Your voicemail message indicators may be displayed differently when roaming internationally.

- A “Message Waiting” indicator icon or a text message is displayed when a voicemail message is received.
- You may see “Missed Call” on your screen prior to receiving a message notification.
- You must call voicemail in order to retrieve messages. Follow the instructions on the previous page to store your voicemail number for easy access.

Retrieve Voicemail Messages

The voicemail retrieval process while traveling is the same as on the Sprint Network; however, you will be required to enter your voicemail passcode.

To retrieve your voicemail messages:

1. From home, tap **Apps**  > **Contacts** .
2. Tap the voicemail entry and then tap the number to call it.
❖ Your phone dials your voicemail number.
3. When your voicemail answers, tap **Star** , enter the passcode, and then tap **#** to access your voicemail.
❖ Your voicemail box is accessed.

International Data Roaming

Sprint Worldwide Wireless Service can also keep you connected using email and Web browsing when traveling in countries in which Sprint offers data service.

Data services are available on both CDMA and GSM/UMTS networks. Check sprint.com/traveltips and sprint.com/sww to determine the services available where you are traveling.

Note: Prior to using your Sprint Worldwide GSM/UMTS Data Services, you must establish and utilize your CDMA data services domestically on the Sprint Network.

Get Started With Sprint Worldwide Data Services

To use Sprint Worldwide Data Services, you will need to have these services activated on your account.



- To activate, call Sprint Worldwide Customer Support at **1-888-226-7212**. Representatives are available 24 hours a day, 7 days a week to assist you.

Access Email and Data Services Internationally

To access your email and browse the Web when traveling, you may need to manually select the carrier that provides Sprint service in your location. You can find a list of carriers for each country where GSM data service is offered at sprint.com/sww. Then, follow the instructions below to select the appropriate carrier network on your phone.

Access International Data Services on GSM/UMTS Networks

To select a GSM data service carrier for a specific country:

1. From home, tap **Apps**  > **Settings**  > **Connections** .
2. Tap **More networks** > **Data roaming**.
3. Tap **Roaming settings**.
4. Under **GSM networks**, select the **Data** checkmark.

 Data roaming on GSM/UMTS networks is set.

Access Email and Data Services Internationally on CDMA Networks

If data service is available on an international CDMA network, then you only need to set the phone to CDMA; you will not need to select the specific carrier. Selecting a specific carrier is only necessary for providers on the GSM network. If your phone has automatically selected a GSM network while traveling, then you will need to set the phone to CDMA to access CDMA data services. (See [Enable Global Roaming Mode](#).) Visit sprint.com/sww for a list of services available in each country.

Contact Sprint for Assistance with International Service

If you experience any issues with voice or data services while outside of the United States, Sprint offers customer support 24 hours a day. In the event that you do experience an issue, try the following actions:

- First try powering your phone off and then back on; this will force your phone to reregister with the network.
- Try manually selecting another network. Information for selecting networks can be found in the phone guide.

If neither of these actions resolves your issue, you will need to contact customer service (see below). When calling to report an issue, the following information will be beneficial in trying to resolve your issue as quickly as possible:

- Your wireless phone number.
- The city and country you are traveling in.
- Any error message that displays on your phone or that you heard when trying to place a call.
- If the issue is with data, were you able to place voice calls?
- If the issue is with voice service, were you able to access data?

Please call the numbers below if you need assistance:

While in the United States: Call **1-888-226-7212**.

While traveling outside the United States:

- In GSM mode: touch and hold **0** and then dial **1-817-698-4199**.
- In CDMA mode: enter the country code and then dial **1-817-698-4199**.

There is no charge for this call from your wireless phone.

From a landline phone when outside the United States:

Sprint Worldwide Customer Support can be reached from a landline phone at **1-817-698-4199**. Access or connection fees may apply. The toll free numbers below can also be used to contact Sprint Worldwide Customer Support in the following countries:

Country	From Landline Phone
Canada	1-866-805-9890

Country	From Landline Phone
Caribbean (Anguilla, Barbados, Cayman Islands, and Dominica)	1-888-226-7212
France	0800-903200
Germany	0800-180-0951
Italy	800-787-986
Mexico	001-877-294-9003
Trinidad and Tobago	1-800-201-7545
United Kingdom	0808-234-6616

Note: This toll free service is available on ordinary landline phones and some public pay phones. This service does not cover any hotel access charges.

Connectivity

The following topics address your phone's connectivity options, including USB file transfer and tethering, Wi-Fi, Bluetooth, and more.

Transfer Files between Your Phone and a Computer

You can use the supplied USB cable to connect your phone directly to your computer and transfer music, pictures, and other content files.

For example, if you have a music album stored on your computer that you want to listen to on your phone with any of the music apps, just attach your phone to the computer and copy the files to the music folder.

File Transfer Tips

- If you want to save data to an SD card on your phone, make sure the SD card is installed and active. See [SD Card](#).
- Avoid removing the SD card while transferring data.
- Data exchange may use the methods outlined in the following table:

Method	Description
Transferring media files	Transfer files between your phone and PC such as pictures, videos, and music.
Transferring images	Transfer picture and video files between your phone and PC.
Connecting MIDI devices	Connect to MIDI-compatible devices.
Charging	Charge your device using a USB cable.
Supplying power	Charge the connected device using a USB cable.

Transfer Files between the Phone and a Computer

1. Connect your phone to your computer using the supplied USB/charging cable.



- Insert the larger end of the cable to the charger/accessory jack at the bottom of the phone.
 - Insert the USB end of the cable into an available USB port on your computer. You may need to remove the USB cable from the charging head to access it.
2. Pull down the status bar to display the notification panel. You will see either **Transferring media files via USB**, **Transferring images via USB**, **Connecting MIDI devices via USB**, or **Charging via USB**.
 - ❖ The files on your phone can now be accessed using your computer.
 - For most transfers, you will want to use **Transferring media files via USB**.
 - To change the option, tap it in the notification panel to open the **Use USB for** window, and then tap the desired option.
 3. On your computer, navigate to the detected device (such as through the My Computer menu) and open it.
 4. If available, select a drive (**Card** for SD card, **Phone** for internal phone storage).
 5. Select a folder (for example, **Music** for songs and albums) and copy files to it from your computer.
 6. When you are done, disconnect your phone from your computer.
 - ❖ The transferred files are now saved to your phone or SD card.

Wi-Fi

Wi-Fi provides wireless Internet access over distances of up to 300 feet. To use your phone's Wi-Fi, you need access to a wireless access point or "hotspot."

The availability and range of the Wi-Fi signal depends on a number of factors, including infrastructure and other objects through which the signal passes.

Turn Wi-Fi On and Connect to a Wireless Network

Use the Wi-Fi settings menu to enable your phone's Wi-Fi radio and connect to an available Wi-Fi network.

1. From home, tap **Apps**  > **Settings**  > **Connections** .
2. Tap **Wi-Fi**.

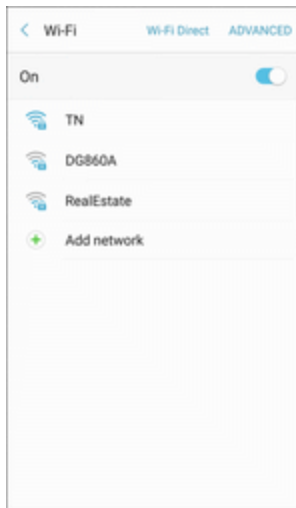





- ❖ The Wi-Fi settings menu appears.
3. Tap **On/Off** to turn Wi-Fi on.
 - ❖ Wi-Fi is enabled. You will see the names and security settings of in-range Wi-Fi networks.
 - To disable Wi-Fi, tap **On/Off** again.
 4. Tap a Wi-Fi network to connect, enter the password (if it is not an open network), and then tap **Connect**.
 - ❖ Your phone is connected to the Wi-Fi network. You will see **Wi-Fi**  in the status bar.
 - The password, for a household wireless LAN router, is sometimes found on a sticker on the router (WEP, WPA, KEY, etc.). Contact the router manufacturer for information. For password for a public wireless LAN, check with user's service provider.
 - Entering a password is not required if an access point is not security protected.

Note: The next time your phone connects to a previously accessed secured wireless network, you will not be prompted to enter the password again, unless you reset your phone to its factory default settings or you instruct the phone to forget the network.

Note: Wi-Fi networks are self-discoverable, which means no additional steps are required for your phone to connect to a Wi-Fi network. It may be necessary to provide a user name and password for certain closed wireless networks.



Wi-Fi Settings

Use the Wi-Fi settings menu to manually set your Wi-Fi connection options.

1. From home, tap **Apps**  > **Settings**  > **Connections** .
2. Tap **Wi-Fi**.
 - ❖ The Wi-Fi settings menu appears.
3. Tap **On/Off** to turn Wi-Fi on.
 - ❖ Wi-Fi is enabled. You will see the names and security settings of in-range Wi-Fi networks.
 - To disable Wi-Fi, tap **On/Off** again.
4. Tap  **More** > **Advanced**.
 - ❖ The advanced Wi-Fi settings menu appears.
5. Configure your Wi-Fi settings.
 - ❖ Your Wi-Fi settings changes are saved.



Disconnect Wi-Fi

You may wish to disconnect from a connected Wi-Fi network without turning Wi-Fi off.

1. From home, tap **Apps**  > **Settings**  > **Connections** .
2. Tap **Wi-Fi**.
 - ❖ The Wi-Fi settings menu appears.
3. Tap the name of the connected access point and then tap **Forget**.
 - ❖ Wi-Fi is disconnected.
 - After disconnecting from an access point, you may need to re-enter the password to reconnect.



Wi-Fi Direct

Use Wi-Fi Direct to connect directly to other Wi-Fi Direct devices simply using Wi-Fi, without an access point or using the Internet.

1. From home, tap **Apps**  > **Settings**  > **Connections** .
2. Tap **Wi-Fi**.
 - ❖ The Wi-Fi settings menu appears.
3. Tap **On/Off** to turn Wi-Fi on.
 - ❖ Wi-Fi is enabled. You will see the names and security settings of in-range Wi-Fi networks.
4. Tap **Wi-Fi Direct**.
 - ❖ The Wi-Fi Direct settings menu appears.
 - Wi-Fi Direct and Wi-Fi are unavailable at the same time.
5. Tap a device with which to connect.
 - If connected using Wi-Fi, you will see a confirmation. Follow the prompts.
6. Accept the connection on the other device.
 - ❖ The phone is connected using Wi-Fi Direct.
 - If a connection is not accepted after a certain period, the connection request is canceled.
 - To stop a connection, tap **End connection** > **OK**.

Hotspot

Hotspot allows you to turn your phone into a Wi-Fi hotspot. When this feature is turned on, you can share your phone's mobile data services using Wi-Fi with other Wi-Fi enabled devices. The feature works best when used in conjunction with 4G data services (although 3G service can also be used).

Important: Use of the Hotspot feature requires an additional subscription. Sign on to your account at sprint.com/mysprint or access your account using Sprint Zone (tap **Apps**  > **Sprint Zone** ) to learn more.

Note: Turning Hotspot on will disable your phone's connection to other Wi-Fi networks.

Set Up Hotspot

1. From home, tap **Apps**  > **Settings** .

2. Tap **Hotspot and Tethering**  > **Hotspot**.

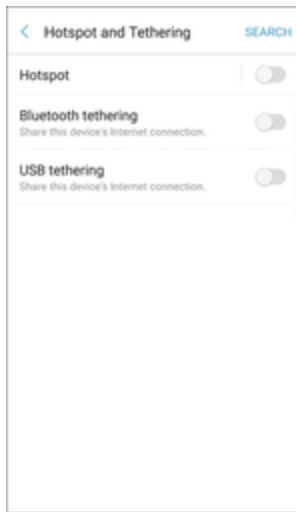

3. Tap **On/Off** to turn Hotspot on.

- ❖ Hotspot is enabled.
 - To disable Hotspot, tap **On/Off** again.

Note: The best way to keep using the phone as a hotspot is to have it connected to a power supply.

Important: Write down the passkey (password) for this communication (shown onscreen).

Connect to Hotspot

1. Enable Wi-Fi (wireless) functionality on your target device (laptop, media device, etc.).
2. Scan for Wi-Fi networks from the device and select your phone hotspot from the network list.
 - You can change the default name by tapping **More options**  > **Configure Hotspot** and entering a new Network name.
3. Select this phone and follow your prompts to enter the passkey (provided on the Hotspot page).
 - ❖ The device is connected using your phone's Hotspot.
4. Launch your Web browser to confirm you have an Internet connection.

Bluetooth

Bluetooth is a short-range communications technology that allows you to connect wirelessly to a number of Bluetooth devices, such as headsets and hands-free car kits, and Bluetooth-enabled handhelds, computers, printers, and wireless phones. The Bluetooth communication range is usually approximately 30 feet.

Bluetooth Hints

Question: Cannot use Bluetooth?

Answer: Is your phone in airplane mode? Bluetooth is unavailable in airplane mode.

Bluetooth Function Cautions

Information may not appear correctly on connected devices depending on the transferred data.

Bluetooth Information

Bluetooth is a technology that enables wireless connection with PCs, Bluetooth devices with hands-free features, etc.

Function	Description
Audio output	Listen to music, etc., wirelessly.
Hands-free calls	Call hands-free, using Bluetooth-capable hands-free devices and headsets.
Data exchange	Exchange data with Bluetooth devices.

Enable the Bluetooth Feature

Use the settings menu to enable or disable your phone's Bluetooth capabilities.

- Wireless connection to all Bluetooth functions is not guaranteed for the phone.
- The phone may not connect properly depending on the other device.
- Noise may be experienced with wireless calls and hands-free calls depending on the conditions.

To enable Bluetooth

1. From home, tap **Apps**  > **Settings**  > **Connections** .

2. Tap **Bluetooth**.



❖ The Bluetooth settings open.

3. Tap **On/Off** to turn Bluetooth on.

❖ Bluetooth is enabled.

- To disable Bluetooth, tap **On/Off** again.

Tip: You can also turn Bluetooth on or off with the toggle menu in the notification panel. Pull down the status bar to display the notification panel and then tap **Bluetooth** to turn Bluetooth on or off.

Note: Turn off Bluetooth when not in use to conserve battery power, or in places where using a wireless phone is prohibited, such as aboard an aircraft and in hospitals.

Pair Bluetooth Devices

Search for and pair nearby Bluetooth devices. Registered Bluetooth devices can be connected simply.

- Enable the Bluetooth function on the Bluetooth devices being paired beforehand.

To pair Bluetooth devices:

1. From home, tap **Apps**  > **Settings**  > **Connections** .

2. Tap **Bluetooth**.



❖ The Bluetooth settings open.

- Nearby devices appear in the “Available devices” list.
- If a target device is not detected, tap **Scan** to search again.

3. Tap a device from the “Available devices” list, and follow the prompts to pair with the device.

❖ The Bluetooth device is paired to your phone.

- Methods to accept a Bluetooth connection differ depending on the devices used.

Unpairing from a Paired Device

1. From the Bluetooth settings menu, tap **Settings**  next to the paired device you wish to unpair.

2. Tap **Unpair**.

❖ The device is unpaired from your phone. To make another connection with the device, you will need to pair again.

Connect to a Paired Bluetooth Device

You can listen to music over a Bluetooth stereo headset, or have hands-free conversations using a compatible Bluetooth headset or car kit. It is the same procedure to set up stereo audio and hands-free devices.

1. From home, tap **Apps**  > **Settings**  > **Connections** .

2. Tap **Bluetooth**.



❖ The Bluetooth settings open.

- Paired Bluetooth devices appear in the “Paired devices” list.

3. Tap a device from the “Paired devices” list.

❖ Your phone connects to the paired device.

The pairing and connection status is displayed below the device’s name in the Bluetooth devices section. When the device is connected to your phone, the Bluetooth paired icon  is displayed in the status bar. Depending on the type of device you have connected, you can then start using the headset or car kit to listen to music or make and receive phone calls.

Note: Due to different specifications and features of other Bluetooth-compatible devices, display and operations may be different, and functions such as transfer or exchange may not be possible with all Bluetooth-compatible devices.

Send Information Using Bluetooth

You can use Bluetooth to transfer information between your phone and another Bluetooth-enabled device such as a phone or notebook computer.

Types of Data You Can Send Using Bluetooth

You can send the following types of information, depending on the device you are sending to:

- Images and videos
- Calendar events

- Contacts
- Audio files

In the instructions below, Contacts data is being used as an example.

Sending Contacts Data Using Bluetooth

1. From home, tap **Contacts** .

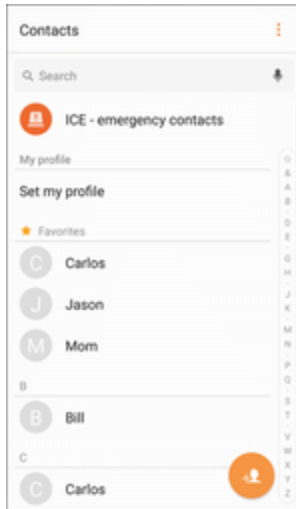

❖ You will see the Contacts list.

2. Tap a contact and select **Details** .
3. Tap **Share**.
4. Tap **vCard file (VCF)** to share the contact as a vCard file, or tap **Text** to share the contact information in a text file.

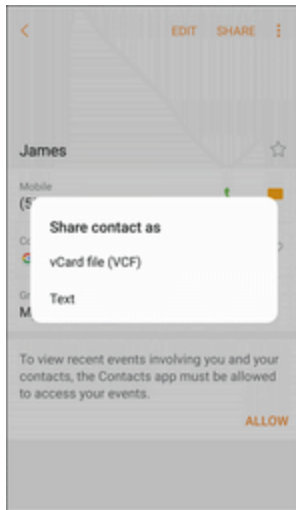

5. Tap Bluetooth and follow the prompts to share the contact.

❖ The selected contact will be shared.

Receive Information Using Bluetooth

Your phone is capable of receiving a wide variety of file types with Bluetooth, including pictures, music tracks, and documents such as PDFs.

1. When another device attempts to send a file to your phone using Bluetooth, you will see a request to accept the file.



2. Tap **Accept**.

❖ The file is sent to your phone.

- When your phone receives a file, you will see a notification. To open the file immediately, pull down the status bar to display the notification panel, and then tap the notification.
- When you open a received file, what happens next depends on the file type:
 - Media files and documents are usually opened directly in a compatible application. For example, if you open a music track, it starts playing in the Music application.
 - For a vCalendar file, select the calendar where you want to save the event, and then tap **Import**. The vCalendar is added to your Calendar events. (For more information on using the Calendar, see [Calendar](#).)
 - For a vCard contact file, if there are multiple vCard files on your storage card, you can choose to import one, several, or all of those contacts to your contacts list.

Tethering

Use Tethering to share your device's Internet connection with a computer that connects to your device using a USB cable, or by Bluetooth.

1. From home, tap **Apps**  > **Settings** .
2. Tap **Hotspot and Tethering** .



3. Select a tethering option: **Bluetooth tethering** or **USB tethering**.
 - ❖ Tethering is turned on, and your phone's Internet connection can be shared with a connected device.
 - For USB tethering, connect your phone to the target device with the supplied USB cable.
 - For Bluetooth tethering, pair your phone with the other device using Bluetooth.

Apps and Entertainment

The topics in this section will explore the features that make your phone so much more than a phone, from the camera and productivity apps to music, entertainment, and more.







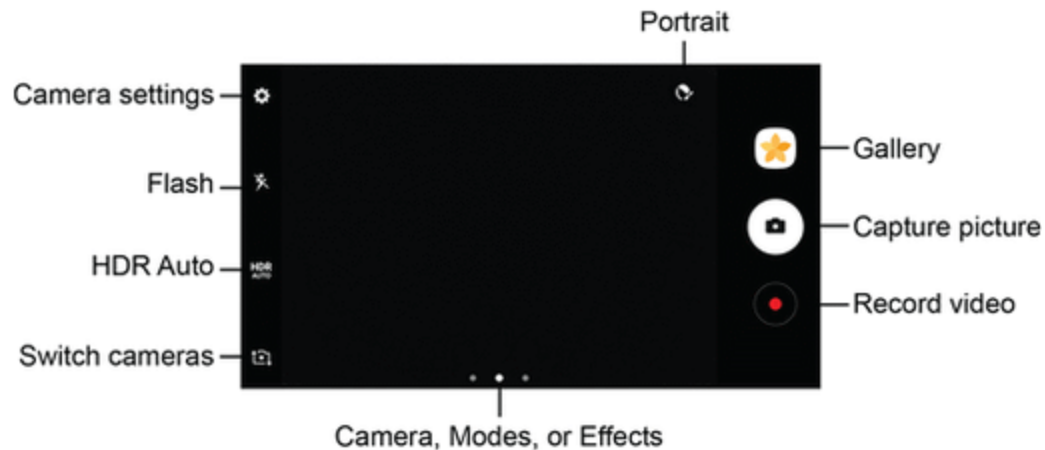

Camera and Video

You can use the camera or video camera to take and share pictures and videos. Your phone comes with a camera with an autofocus feature that lets you capture sharp pictures and videos.

Camera Overview

The camera's viewfinder screen lets you view your subject and access camera controls and options.



-  **Portrait:** Adjust skin tone of faces.
-  **Gallery:** View your picture or video in the Gallery application.
-  **Capture picture:** Take a picture.
-  **Record video:** Begin recording video.
-  **Camera, Modes, or Effects:** Swipe right to change the shooting mode. Swipe left to add an effects filter.
-  **Switch cameras:** Switch between the rear camera and the front camera.
-  **HDR Auto:** Enable the light sensitivity and color depth features of the device to produce a brighter and richer picture.
-  **Flash:** Activate or deactivate the flash. Toggle through flash options—on, auto, or off (rear camera only).
-  **Camera settings:** Opens the camera settings menu and lets you change additional camera settings. See [Camera Settings](#).

Learn More About Your Phone's Camera

For an overview of your phone's camera and its features, you can access more information through the camera settings menu.

1. From home, tap **Apps**  > **Camera** .

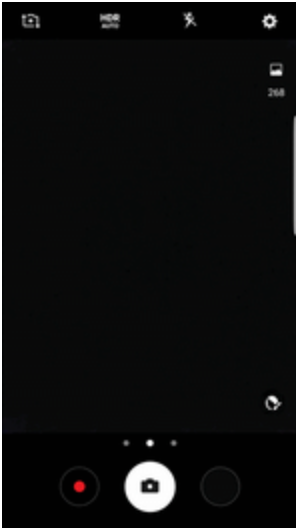

❖ The camera viewfinder appears.

2. Tap **Settings**  > **Help**, and tap a topic to learn more.

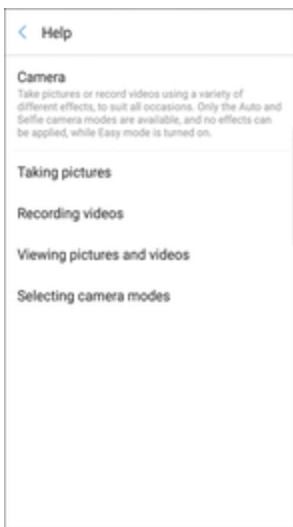

Take Pictures and Record Videos

The following topics teach you how to take pictures and record videos with your phone's camera.

Capturing Pictures/Videos

- **File Format for Pictures:** File format for pictures is JPEG or RAW format.
- **File Format for Videos:** File format for videos is MPEG4.

! Camera Cautions

If Lens Becomes Dirty: Fingerprints/smudges on lens prevent capturing of clear still images/videos. Wipe lens with a soft cloth beforehand.

Avoid Exposure to Direct Sunlight: Be careful not to expose lens to direct sunlight for long periods. May discolor color filter and affect color of images.

! Flash Warning

Do not shine the flash close to eyes. Do not look directly at the flash when shining. Do not shine the flash at other people's eyes. May affect eyesight, etc.

Take a Picture

You can take high-resolution pictures using your phone's camera.

Note: If you have an SD card installed, pictures and videos are stored to the SD card. If no card is installed, pictures and videos are saved to your phone's memory.

1. From home, tap **Apps**  > **Camera** .

❖ The camera viewfinder appears.

2. Aim the camera at your subject.

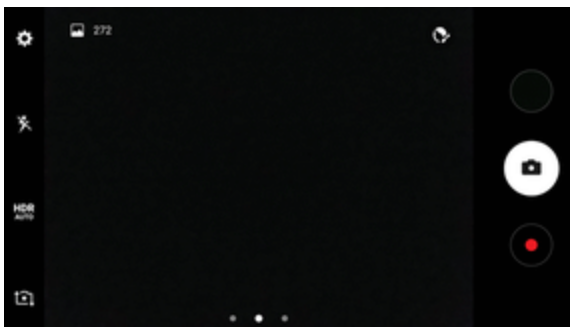

❖ Auto focus activates.

3. Tap **Capture picture**  to take the picture.

Record Videos

Record high-quality videos using your phone's video camera.

Note: If you have an SD card installed, pictures and videos are stored to the SD card. If no card is installed, pictures and videos are saved to your phone's memory.

1. From home, tap **Apps**  > **Camera** .



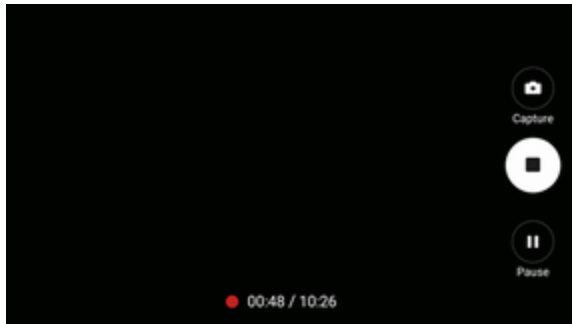

❖ The camera viewfinder appears.

2. Aim the camera at your subject and then tap **Record** .



❖ Video recording begins.

3. The following actions are available:

- Tap **Capture**  to take a picture while recording.
- Tap **Pause**  to pause recording.
- Tap **Resume**  to resume recording.
- Tap **Stop**  to stop recording.

❖ The camera stops recording and the video is captured and saved to your phone or SD card.

Shooting Mode

Several visual effects are available. Some modes are not available when taking self-portraits.

1. From home, tap **Apps**  > **Camera** .

❖ The camera viewfinder appears.

2. Swipe to the right for the Mode options. Each section indicates which camera (front or rear) the modes are available for.

■ Rear camera

- **Auto:** Allow the camera to evaluate the surroundings and determine the ideal mode for the picture.

- **Pro:** Manually adjust the ISO sensitivity, exposure value, white balance, and color tone while taking pictures.
 - **Panorama:** Create a linear image by taking pictures in either a horizontal or vertical direction.
 - **Selective focus:** Change the focus of pictures after they have been taken. You can focus on subjects near to the camera, far away from the camera, or both.
 - **Slow motion:** Record videos at a high frame rate for viewing in slow motion. You can play a specific section of each video in slow motion after recording it.
 - **Hyperlapse:** Create your own time lapse video by recording at various frame rates. The frame rate is automatically adjusted depending on the scene being recorded and the movement of the device.
 - **Food:** Take pictures that emphasize the vivid colors of food.
- **Front camera**
 - **Selfie:** Take selfie shots and apply various effects, such as an airbrushed effect.
 - **Wide selfie:** Take wide-angle selfie shots to fit more people into your pictures.
 - **Common**
 - **Virtual shot:** Create multi-directional views of objects.
 - **Video collage:** Create your own short collages and slow-motion videos without any editing tools.
 - **Live broadcast:** Broadcast live on YouTube. Share your link with friends so they can watch your video in real time. For more information, see [Live Broadcast](#).
 - **Download:** Download additional shooting modes from the Galaxy Apps store.
 - **More options:** See more options for the camera modes.

View Pictures and Videos Using Gallery

Using the Gallery application, you can view pictures and watch videos that you have taken with your phone's camera, downloaded, or copied onto your storage card or phone memory. You can also take a look at your pictures and your friends' pictures that are on your social networks (Facebook and Flickr® only).

For pictures that are on your storage card or phone memory, you can do basic editing such as rotating and cropping. You can also easily assign a picture as your contact picture or wallpaper and share pictures with your friends.

View Pictures and Videos

You can access and view all your stored pictures and videos from your phone's Gallery.

1. From home, tap **Apps**  > **Gallery** .

❖ The album list opens.

2. Tap an album (such as Camera).

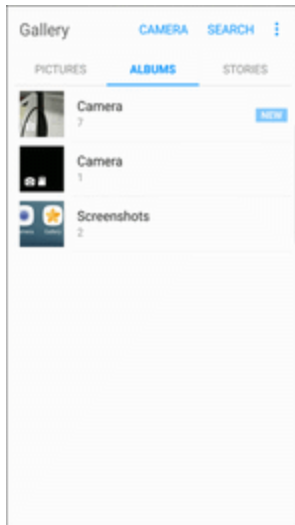

❖ The list of pictures and videos for the album opens.

- To select another album, tap **Back**  to return to the Albums tab.

3. Tap an image to view the picture or video.

❖ The picture opens or the video begins playing.

- Tap a picture or video to view it full screen.
- When viewing pictures and videos, you can touch and hold an image to open a selection menu and choose what to do with the picture or video.

Pictures and Videos: Review Screen

After capturing a picture or video, from the camera screen, tap the thumbnail image to see the item in the review screen. From there, you can access options such as save, view, send, or delete the picture or video.

Pictures and Videos: Options while Viewing

- **Zoom In or Out on a Picture or Video:** Tap the screen twice or pinch the screen to zoom in or out on a picture or video.
- **Viewing Videos:** Use the controls to play, pause, or stop the video playback.

After selecting an album from the Albums tab, you can browse through the pictures and videos of that album. Tap a picture or video to view it in full screen. By default, the pictures and videos in an album are displayed in grid view.

Note: When viewing pictures, you can touch and hold on a picture or video to open a selection menu and choose what to do with the picture or video.

Camera Settings

You can adjust your camera's settings using the icons on the main camera screen and the full camera settings menu.

Switch Cameras

Your phone lets you use different types of cameras depending on your settings and downloads.

1. From home, tap **Apps**  > **Camera** .

❖ The camera viewfinder appears.

2. Tap **Switch cameras** .

– or –

Swipe the screen up or down.

❖ The camera changes from the rear camera to the front camera or vice versa.

Set Camera Functions

You can configure your camera's settings to fit any situation and event.

1. From home, tap **Apps**  > **Camera** .

❖ The camera viewfinder appears.

2. Tap **Settings** .

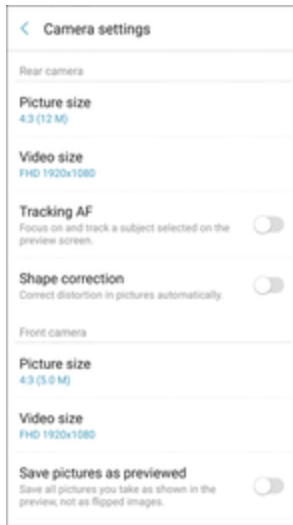

❖ The camera settings menu opens.

3. Select your desired settings.

- **Rear camera**

- **Picture size:** Select a resolution. Use higher resolution for higher quality. Higher resolution pictures take up more memory.
- **Video size:** Select a resolution. Use higher resolution for higher quality. Higher resolution videos take up more memory.
- **Tracking AF:** Focus on and track a subject selected on the preview screen.
- **Shape correction:** Correct distortion in pictures automatically.

- **Front camera**

- **Picture size:** Select a resolution. Use higher resolution for higher quality. Higher resolution pictures take up more memory.
- **Video size:** Select a resolution. Use higher resolution for higher quality. Higher resolution videos take up more memory.
- **Save pictures as previewed:** Save the self-portrait or self-recording as viewed on the camera screen, not as flipped images.
- **Ways to take pictures:** **Tap to take pics** (tap the screen to take selfies), **Gesture control** (detect your palm and automatically take a picture two seconds later), and **Use heart rate sensor** (once your face has been recognized, tap the heart rate sensor to take your picture).

- **Both cameras**

- **Timer:** Take time-delayed pictures or videos.

- **Motion photo:** Create a short video by taking pictures.
- **Video stabilization:** Activate anti-shake. Anti-shake helps to keep the focus steady when the camera is moving.
- **Grid lines:** Display viewfinder grid lines to help composition when selecting subjects.
- **Location tags:** Attach a GPS location tag to the picture.
- **Review pictures:** Set to show pictures after taking them.
- **Quick launch:** Open camera by pressing the Home key twice in quick succession.
- **Storage location:** Select the memory location for storage. This option only appears if an optional memory card (not included) is installed.
- **Voice control:** Take pictures by saying “Smile”, “Cheese”, “Capture”, or “Shoot”, or record videos by saying “Record Video”.
- **Volume keys function:** Use the Volume key as the camera key, the record key, or as a zoom key.
- **Reset settings:** Reset the camera settings.
- **Help:** View information on using the camera.

Live Broadcast

Share what is happening around you using YouTube.

To access the Live Broadcast:

1. From home, tap **Apps**  > **Camera** .



❖ The camera viewfinder appears.



2. Swipe to the right and tap **Live broadcast**.

Note: You need to sign in to your Google Account and enable Live Broadcast in your YouTube settings to use this feature.

Live Broadcast Options





The following options are available:

-  **Rear/Front:** Choose which camera to record from.
-  **Invite:** Invite contacts to view your live broadcast by sending them a link.
-  **Settings:** Set your privacy settings, Video size, Auto save, and manage your account.

-  **Live:** Start recording your live broadcast.
-  **Share:** Share while recording your live broadcast.
-  **Stop:** End your live broadcast.

Record a Live Broadcast

Record and instantly share your videos to YouTube.

1. From home, tap **Apps**  > **Camera** .
- ❖ The camera viewfinder appears.
2. Swipe to the right and tap **Live broadcast**.
3. Tap **Invite**  and select contacts to share your live broadcast with. You will also have the option to share your live broadcast during recording and when you finish recording.
4. Tap **Live**  to begin recording.
5. When you are finished, tap **Stop** .

Share a Broadcast

You can share your live broadcast with contacts before recording, or share the link after you have finished recording and it has been posted to YouTube.

To invite contacts:

1. From home, tap **Apps**  > **Camera** .

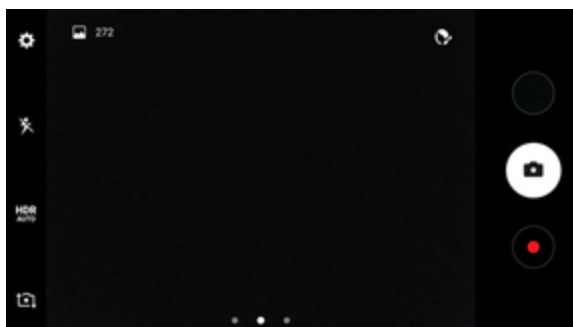

- ❖ The camera viewfinder appears.
2. Swipe to the right and tap **Live broadcast**.
3. Tap **Invite**  and select contacts or groups to share your live broadcast with.

4. Tap **Save** to send invites.

To share a Live broadcast while broadcasting:

- Tap **Share**  and select a sharing method to share your Live broadcast.

To share a Live broadcast after broadcasting:

- After recording, tap **Share link** and select a sharing method to share your Live broadcast.

Live Broadcast Settings

Customize your Live Broadcasts.

1. From home, tap **Apps**  > **Camera** .

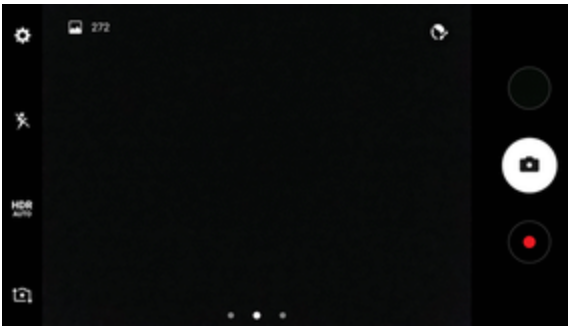

 The camera viewfinder appears.

2. Swipe to the right and tap **Live broadcast**.

3. Tap **Settings**  and select an option to customize:



- **Account:** Select a Google Account for Live broadcast.
- **Privacy:** Choose either to have your videos unlisted where only friends with a link can view them, or public where anyone can view them.
- **Video size:** Tap to choose a size option.
- **Social media settings:** Share your link with social media when you start broadcasting.
- **Auto save:** Tap to enable auto saving your videos to the Gallery app.
- **Auto dim:** Dims the brightness if you broadcast without touching the screen.
- **Add shortcut on Home screen:** Tap to create a shortcut to Live broadcast on the Home screen.

Productivity

Use your phone to stay ahead of the game with calendar, navigation, alarm, office, and more productivity apps.

1Weather

Receive real-time local weather information at any location in the world. Access seven-day and hourly weather forecasts for your area.

1. From home, tap  **Apps** >  **1Weather**.
2. Follow the prompts to update the app in Play Store, and then explore the app to customize your views, add locations, and more.

Calculator

Your phone's convenient built-in calculator lets you perform basic and advanced mathematical equations.

1. From home, tap **Apps**  > **Calculator** .

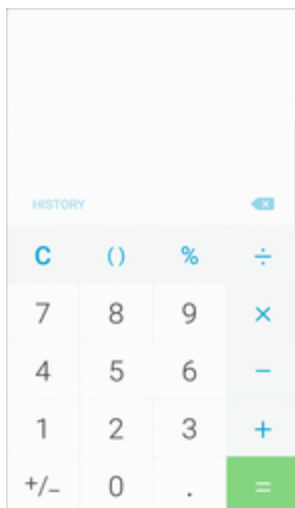

- ❖ The calculator app launches.
2. Tap keys for calculations.
- ❖ Calculation results appear.

Tip: To use the scientific calculator, make sure Auto rotate is turned on (**notification panel** > **Auto rotate**) and rotate the screen to the landscape orientation.

Calendar

Use Calendar to create and manage events, meetings, and appointments. Your Calendar helps organize your time and reminds you of important events. Depending on your synchronization settings, your phone's Calendar stays in sync with your Calendar on the Web, Exchange ActiveSync calendar, Google Calendar™, and Outlook® calendar.

In order to sync with your Google calendar, you must sign in to a Google Account on your phone. See [Google Account](#).

Calendar Operations

- **View Today's Calendar:** From the Calendar, tap **Today**.
- **Change Calendar View:** From the Calendar, tap **Year**, **Month**, **Week**, **Day**, or **Tasks** to change the current view.
- **View Next/Previous Month (Month View):** From the Calendar, swipe left or right.
- **View Next/Previous Week (Week View):** From the Calendar, swipe left or right.
- **View Next/Previous Day (Day View):** From the Calendar, swipe left or right.

Add an Event to the Calendar

Add events to your calendar directly from the Calendar application.

1. From home, tap **Apps**  > **Calendar** .



-  The Calendar app opens.

2. Tap **Add** .

❖ The add event window opens.

3. Enter an event title, start date/time, end date/time, etc., and then tap **Save**.

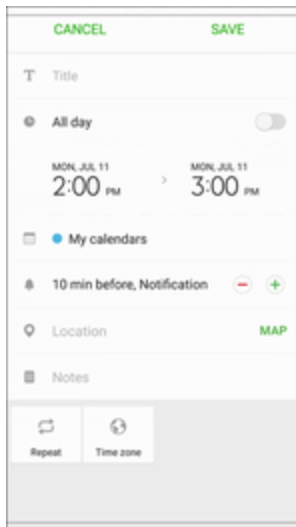

❖ The event is added to your calendar.

View Calendar Events

You can display the Calendar in daily, weekly, monthly, or agenda view. To change the Calendar view, tap the current view in the top right corner, and then tap **Year**, **Month**, **Week**, **Day**, or **Tasks**.

1. From home, tap **Apps**  > **Calendar** .

❖ The Calendar app opens.

2. Tap a date and then tap an event.

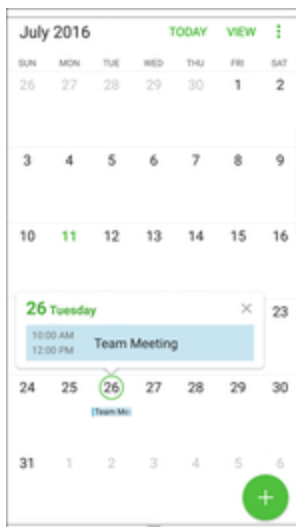

- ❖ The event details appear.
 - Tap the event to edit it.

Sync Calendars

You can select which calendars you would like to sync on your phone, along with what types of information you want to sync.

1. From home, tap **Apps**  > **Calendar** .

- ❖ The Calendar app opens.

2. Tap **More** > **Manage calendars**.

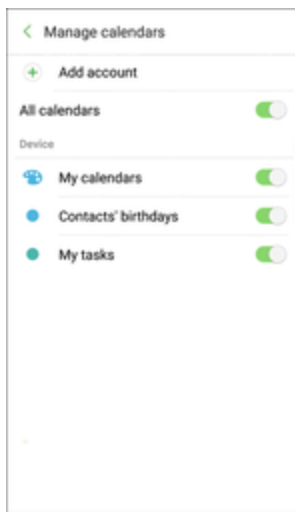

3. Select sync options by sliding the selector next to each option.



- ❖ The sync settings have been updated.

4. Tap **Back**  to return to Calendar view.

- ❖ The selected calendars sync.

Synchronize an Exchange ActiveSync Calendar

If you have set up a Microsoft Exchange ActiveSync account on your phone, you can also synchronize Exchange ActiveSync calendar events on your phone. Calendar events on your Exchange ActiveSync will also show in Calendar if you chose to synchronize with the Exchange ActiveSync Server.

1. From home, tap **Apps**  > **Settings**  > **Cloud and accounts**  > **Accounts** > **Microsoft Exchange ActiveSync**.

- To confirm your sync settings, tap the account name and make sure the **Sync Calendar** box is selected. Tap **Back**  to return to the sync menu.

2. Tap **Sync all**.

Calendar Settings

Configure settings for your phone's Calendar app.

1. From home, tap **Apps**  > **Calendar** .

❖ The Calendar app opens.

2. Tap **Calendar** > **More options**  > **Settings** to configure these options:

- **First day of week:** Choose a day to start each calendar week.
- **Show week numbers:** Enable or disable display of week numbers on the calendar.
- **Hide declined events:** When enabled, events for which you declined the invitation are not shown on the calendar.
- **7-day weather forecast:** When enabled, weather information from AccuWeather.com displays on the calendar.
- **Notifications:**
 - **Notification sound:** Choose a sound for calendar event notifications.
 - **Vibration:** Enable or disable vibration, to play for calendar event notifications.
- **Set default reminders:** Set default reminders for Events and All-day events.
- **About Calendar:** View information about the Calendar app.
- **Lock time zone:** When enabled, event times will be locked to the time zone you select. Times and dates will not change, even if you travel to another time zone.

Note: If Microsoft Exchange ActiveSync doesn't appear under the Accounts heading in the Settings menu, you do not have an Exchange ActiveSync account configured on the phone. For information about adding an account, see [Add an Exchange ActiveSync Account](#).

Caller ID

See who is calling, even if the caller is not in your contact list. This service requires a subscription.

- From home, tap  **Apps** >  **Caller ID**.

Clock

Your phone has a clock app that lets you set alarms, view time in time zones around the world, use a stopwatch, or set a timer.

Check the Time

You can check the phone any time on your phone. The current time displays in the upper right corner of the status bar. Many widgets and lock screens also display the time and provide options for how time is displayed.

Set Alarms

Set multiple alarms using your phone's Clock app.

1. From home, tap **Apps**  > **Clock** .



❖ The Clock appears.

2. Tap the **Alarm** tab.
3. Tap **Add alarm** .
4. Set the alarm options, including time, days, repeat pattern, alarm type, alarm tone, and volume, and then tap **Save**.

❖ The alarm is set.

Phone at Alarm Time

- At the set alarm time, the phone sounds the alarm and/or vibrates.
- **Stopping an alarm:** When the alarm sounds, tap **Dismiss**.

Additional Clock Features

Your phone's clock app provides additional useful features including world clock, stopwatch, and timer functions. All features are available from the clock app display.

- From home, tap **Apps**  > **Clock** .



- ❖ The Clock appears.

World Clock

The world clock lets you keep track of the current time in multiple cities around the globe.

1. From the clock app, tap **World Clock**.
2. Tap **Add city**  and select a city.
3. Repeat to add multiple cities.

Stopwatch

The stopwatch lets you time events down to the hundredth of a second.

1. From the clock app, tap **Stopwatch**.
2. Tap **Start** to begin timing.
3. Tap **Stop** to stop timing.
 - Additional options include **Lap** to keep track of laps, **Restart** to continue timing, and **Reset** to reset the stopwatch to zero.

Timer

The timer provides a countdown timer for up to 99 hours, 59 minutes, and 59 seconds.

1. From the clock app, tap **Timer**.
2. Use the keypad to set the length of the timer.
3. Tap **Start** to begin the timer.

Drive

Use Google Drive to open, view, rename, and share your Google Docs and files.

- From home, tap **Apps**  > **Google**  > **Drive** .

Google Maps

Use the Google Maps app to determine your location, find directions, browse local businesses and attractions, rate and review places, and more.

Enable Location Services on Your Phone

Before using any location-based services, you must enable your phone's location feature. For information about setting your phone's location options, see [Location Settings](#).

View Maps of Specified Places

Use Google Maps to locate and map a specific address or destination.

1. From home, tap **Apps**  > **Google**  > **Maps** .

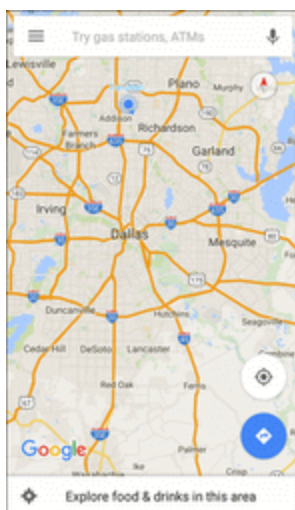

❖ Google Maps opens.





- If prompted, follow the prompts to accept terms of use.

2. Tap the **Search** field to start a search.

3. Enter an address, city, facility name, etc., and then tap a candidate in the results list.



❖ A map of the specified location opens.

Google Maps Operations

- **Viewing Current Location:** From the Maps app, tap **Location** .
- **Obtain Useful Area Information for Current Location:** From the Maps app, tap the **Search** field, enter the information you are looking for, and then tap a result to view it.
- **View Traffic Information, Aerial Photos, Etc., in Maps:** From the Maps app, tap **Menu**  and then tap **Traffic, Satellite, Google Earth**, etc.
- **Check Route to Destination:** From the Maps app, tap **Route** , enter your current location and your destination, tap a method of transport (car, public transit, bicycle, or on foot), and then tap **Search for route**.
 - Route candidates appear in a list.
- **Check Detailed Operation for Maps:** From the Maps app, tap **Menu**  > **Help**.

Google Search

Search not only the Internet, but also the apps and contents of your device.

1. From home, tap the Google search bar or tap **Apps**  > **Google**  > **Google** .

❖ The Search window opens.



- If confirmation appears, follow the prompts.
- If a description for Google Now appears, tap **Next** and read information. Tap **Enable** on the last page if you want to use Google Now.

2. Type your search keywords and tap **Search** .

❖ Search results appear.

- To search by voice, tap  in the search bar and speak your search terms.

Google Search Operations

- **Changing Search Information:** In the search window, tap **Menu**  > **Settings** > **Phone search** and select where to search.
- **Using Google Now:** Google Now automatically searches for information based on search keywords used, your current location, etc., and presents search results in the search screen. Google Now also informs users of scheduled events.
 - To enable Google Now, in the search window, tap **Menu**  > **Settings** > **Now cards** > **Show cards**.

Lookout



Configure and manage key security options, such as anti-virus and anti-malware technology, a lost and stolen device locator service, an application privacy adviser, and a backup service.

- From home, tap **Apps**  > **Sprint**  > **Lookout** .

My Files

Manage your sounds, images, videos, Bluetooth files, Android files, and other data in one convenient location. Located in the Samsung folder in the Apps list.

To view files in My Files:

1. From home, tap **Apps**  > **Samsung**  > **My Files** .
2. Tap a category to view the relevant files or folders.
3. Tap a file or folder to open it.

Note: Different folders may appear depending on how your phone is configured.

File Groups

Files stored in the device are organized into the following groups:





- **Recent files:** View recently saved files.
 - This only appears if one or more files have been accessed recently.
- **My device:** View folders and files located on the device.
- **SD card:** View folders and files located on the optional SD card (not included).
 - This option only appears if an optional SD card is installed.
- **Downloads:** View all apps and files that have been downloaded to the device.

- **Documents:** View document files.
- **Images:** View image files.
- **Audio:** View audio files.
- **Videos:** View video files.
- **Google Drive:** Use a Google account for cloud storage.

Note: Cloud drives vary depending on the services you sign in to.

My Files Options

Use My File options to search, edit, clear file history, and more.

- From home, tap **Apps**  > **Samsung**  > **My Files** . The following options are available:
 - **Search:** Search for a file or folder.
 - **More options** : Tap for the following options:
 - **Manage storage usage:** Configure your storage settings.
 - **Settings:** Configure your My Files app settings.

Photos





The Photos app automatically backs up your photos and videos to your Google Account.

- From home, tap **Apps**  > **Google**  > **Photos** .

S Voice

Use the S Voice voice recognition application to activate a wide variety of functions on your phone.





This is a natural language recognition application. You can ask questions (Is it raining in Dallas?) or speak commands (Show me where to find cheap gas).

1. From home, tap **Apps**  > **Samsung**  > **S Voice** .
2. Review and accept the terms and conditions, and then tap **Next**.
3. Tap **Start** and follow the instructions to set up a wake-up command.
4. To use S Voice, speak a command. The screen gives you some examples.
5. Tap **Microphone**  if the phone does not hear you, or to give it a command.

Note: You may have set up the S Voice wake-up command during the phone's setup screens.

S Voice Settings

Configure options for using your voice to interact with your phone.

1. From home, tap **Apps**  > **Samsung**  > **S Voice** .
2. Tap **More options**  > **Settings** to configure options:
 - **Voice wake-up:** Launch S Voice by speaking a wake-up command.
 - **Wake up in secured lock:** Make calls, take pictures, play music, or perform tasks using S Voice using voice commands without unlocking your phone.
 - **Language:** Choose a language to use for S Voice.
 - **Voice feedback:** Enable spoken feedback when using S Voice.
 - **Auto start speakerphone:** When enabled, the speaker is automatically turned on when you make a call with S Voice.
 - **Home address:** Configure your home address.
 - **Erase data:** Erase the data you have stored on the server and restore the default S Voice settings.
 - **Help:** View information about using S Voice.
 - **About S Voice:** View S Voice version information.

Samsung Gear

Connect your device to your Samsung Gear using this application.

- From home, tap **Apps**  > **Samsung**  > **Samsung Gear** .

Samsung Notes



The Samsung Notes app helps you create, edit, and manage all the notes on your phone.

Sign in to your Samsung account to access your notes in Samsung Notes from any device.

With Samsung Notes, create content by typing, writing, drawing, and even recording voice, video, or taking pictures. Templates are provided to make content creation easy and help keep things organized.



Compose a Note

You can create notes using the Samsung Notes app.

1. From home, tap **Apps**  > **Samsung Notes** .
2. Tap **Create**  and type a note. Available options include:
 - **Text**: Use the keyboard to type text.
 - **Pen**: Use the S Pen to write text.
 - **Brush**: Create a drawing.
 - **Image**: Insert an image into the note.
 - **Voice**: Use your voice to insert text into the note.
 - Tap **Save** when finished.



Edit Notes

You can make edits to notes you create.

1. From home, tap **Apps**  > **Samsung Notes** .
2. Tap a note to view it.
3. Tap the content and make edits.
4. When you are finished, tap **Save**.



Browse Notes

You can browse notes you create.

1. From home, tap **Apps**  > **Samsung Notes** .
2. Browse note entries by swiping up or down.
3. To search for a note, tap **Search**.

Notes Options

You can edit, share, or manage notes.

1. From home, tap **Apps**  > **Samsung Notes** .
2. While browsing notes, tap **More** for the following options:
 - **Edit**: Select notes to share, delete, or move.
 - **Sort**: Change the way notes are organized.
 - **List/Grid view**: Switch between List view and Grid view.

- **Settings:** View settings for the Samsung Notes app.
- **Help:** View help topics for the Samsung Notes app.

Samsung Pay

Samsung Pay™ is the new way to pay with your Samsung Galaxy device. It is simple, secure and works in more stores than any other mobile payment service.

Samsung Pay is accepted almost anywhere you can swipe or tap your credit card.



Note: Before use, please confirm the NFC feature is enabled on your device (see [NFC and Payment](#)).

Note: For added security protection, if using Samsung Pay on multiple devices; you must first sign in and then add all of your cards in again per each device. Your card information is not stored on a cloud service.

Set Up Samsung Pay

Samsung Pay is secure, easy to set up, and simple to use with your Samsung Galaxy device.

To set up Samsung Pay:



1. From home, tap **Apps**  > **Samsung Pay** .
2. Tap **Install** and follow the prompts.

Note: You must log in to your Samsung account or create a new Samsung account to use Samsung Pay.

Simple Pay

Access Samsung Pay from the Screen off, Lock Screen or Home screen using Simple Pay.

To customize Simple Pay:

1. From home, tap **Apps**  > **Samsung Pay** .
2. Tap **More** > **Settings** > **Use Simple Pay**.
3. Tap **On/Off** to enable Simple Pay on each screen.

To use Simple Pay:

1. From any screen, swipe up from the Home key.
 - ❖ Your payment card and Simple Pay are displayed.
2. Drag the card down to close Simple Pay.

Use Samsung Pay

Use Samsung Pay quickly and conveniently whenever you have your device with you.

1. From home, tap **Apps**  > **Samsung Pay** .

– or –

From any screen, swipe up from the Home key.

2. Select a card to pay with and authorize payments by scanning your finger on the Home key or entering your Samsung Pay PIN.
3. Hold your phone over the store's card reader.
 - When your payment is complete, a receipt is sent to your registered email.

Use Gift Cards with Samsung Pay

Purchase, send, and redeem gift cards from an expanding selection of your favorite retailers.

1. Visit samsung.com/us/samsung-pay.
2. Scroll down to “Gift cards available on Samsung Pay” and click the **See retailers** link.

Secure Your Information

Samsung Pay is designed with the latest security technology and works on most recent Samsung Galaxy devices. Payments are authorized with your fingerprint or PIN and each transaction uses a unique token each time, so your device only allows payments with your consent.

For more information about Samsung Pay, visit: samsung.com/us/samsung-pay.

For Samsung Pay support, visit: samsung.com/us/support/owners/app/samsung-pay.

Sprint Family Locator

Use Sprint Family Locator to locate any phone on your Sprint family plan instantly—from your mobile phone, tablet or computer.

- From home, tap **Apps**  > **Sprint**  > **Sprint Family Locator** .

Tech Expert

Get access to a US-based technical expert.

- From home, tap **Apps**  > **Tech Expert** .

Uber

Hire a private driver in more than 130 cities and 30 countries. Uber is an entirely new and modern way to travel.

- From home, tap **Apps**  > **Uber** .

Entertainment and Activities

The following topics provide an overview of your phone's entertainment apps, from music players and YouTube, to health apps, games, and more.

Amazon Apps

Access such Amazon apps as amazon.com, Kindle, Amazon Music, and more through the apps located in the Amazon folder.

Amazon

Shop at amazon.com from your device.

- From home, tap **Apps**  > **Amazon**  > **Amazon** .

Amazon Kindle

Download books for reading right on your device. You must have an account with Amazon to use the Kindle application.

- From home, tap **Apps**  > **Amazon**  > **Amazon Kindle** .

Amazon Music

Purchase, download, and play music from Amazon.

- From home, tap **Apps**  > **Amazon**  > **Amazon Music** .

Amazon Photos

Store your photos on Amazon's cloud server.

- From home, tap **Apps**  > **Amazon**  > **Amazon Photos** .

Amazon Video

Watch Amazon Prime movies and videos on your phone.

- From home, tap **Apps**  > **Amazon**  > **Amazon Video** .

App Spotlight

Discover new apps from the Google Play store.

- From home, tap **Apps**  > **Sprint**  > **App Spotlight** .

Galaxy Apps

Discover apps designed exclusively for your Galaxy phone.

Note: You must sign in to a Samsung account in order to download Galaxy Apps.

- From home, tap **Apps**  > **Samsung**  > **Galaxy Apps** .

Google Play Music App

The Google Play Music app lets you browse, shop, and play back songs purchased from Google Play as well as songs you have loaded from your own music library. The music you choose is automatically stored in your Google Play Music library and instantly ready to play using streaming or download.

For more information about Google Play Music, visit play.google.com/about/music.

Note: For information about loading music onto your phone, see [Transfer Files between Your Phone and a Computer](#).

Play Music with Google Play

Use the Google Play Music app to listen to all your music on your phone. Compatible music file formats include: MP3 (.mp3), AAC (m4a), WMA (.wma), FLAC (.flac), OGG (.ogg), DRM protected AAC (m4p), and ALAC (.m4a).

1. From home, tap **Apps**  > **Google**  > **Play Music** .

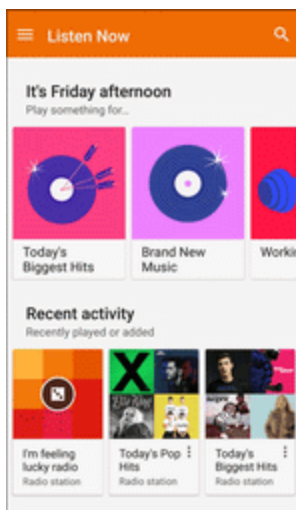

- ❖ The Play Music app opens to the Listen Now screen.

- To view additional music options, tap **Menu**  and select an option (Listen now, Top charts, New releases, Music library, Browse stations, or Shop).
- Tap an item from the category window and then tap a song.
 - ❖ The song begins playing.

Google Play Music Screen Layout

The following diagram outlines the main features of the Play Music app player screen.



Feature	Description
Music list	View current playlist or queue
Options menu	Access the options menu.
Music image/album name	Display music images and album names (if available).
Shuffle playlist	Shuffle the current playlist or queue.
Song length	The length of the song.
Rate (thumbs up/thumbs down)	Rate the current song.
Next song	Play the next song.
Play/pause	Play or pause the current song.
Previous song	Play the previous song.



Feature	Description
Elapsed time	Amount of time the song has been playing.
Repeat/play next	Repeat the current song or play the next song queued.
Music title/artist	Displays music title and artist (if available).

Create Playlists in Google Play Music

Organize music into playlists to fit every occasion.

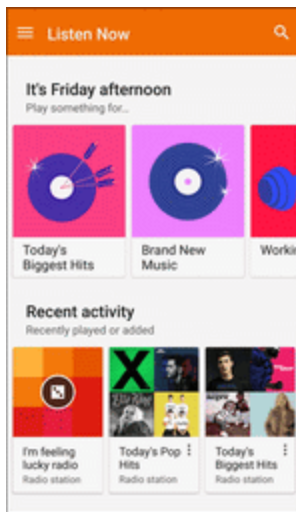
1. From home, tap **Apps**  > **Google**  > **Play Music** .



- ❖ The Play Music app opens to the Listen Now screen.
2. Tap **Menu**  to view your library or playlists, or to access Google Play Music online.
 3. From a list displaying songs, tap an item from the category window and then tap **Add to playlist**.
 4. Tap **New playlist**.
 5. Enter a name and tap **OK**.
- ❖ The playlist is created.
6. Return to the library view and select **Albums** or **Songs**.
 7. Tap **More options**  next to an item and then tap **Add to playlist** > **<playlist name>**.
- ❖ The song or album is added to the playlist. Repeat to add more items to the playlist.

Adding Currently Playing Music to a Playlist

- From the player view, tap **More options**  > **Add to playlist** > <playlist name>.
- ❖ The music is added to the playlist.

Live Soccer & TV

Watch live TV and sports on the go with fuboTV. A subscription is required to use this service.

- From home, tap **Apps**  > **Live Soccer & TV** .

NextRadio

Listen to your favorite FM radio stations on the go with NextRadio. Tune in to any FM frequency in your area and listen to the radio without the cost of streaming music.

- From home, tap **Apps**  > **Sprint**  > **NextRadio** .

Note: To listen to radio from your device, you must plug in either headphones or a speaker cable to the headphone jack on bottom of the device. To listen through the device's speaker (after plugging in headphones), tap **More options**  > **Output to speaker**.

PEN.UP

PEN.UP is an online community app that brings together anyone that uses the S Pen to draw, sketch, scribble or paint. Share photos, comment on other creations, or just browse through the pages for something to add to your personal collection.



- From home, tap **Apps**  > **Samsung**  > **PEN.UP** .

S Health

Manage your health with the S Health wellness application. Set fitness goals, check your progress, and keep track of your overall health.

Caution: The information gathered from this device, S Health, or related software is not intended for use in the diagnosis of disease or other conditions, or in the cure, mitigation, treatment or prevention of disease.

The accuracy of the information and data provided by this device and its related software, including heart rate readings, may be affected by factors such as environmental conditions, skin condition, specific activity performed while using/wearing the device, settings of the device, user configuration/user-provided information, placement of the sensor on the body, and other end-user interactions. For more information on proper wear and use, see samsung.com/us/heartratesensor.

1. From home, tap **Apps**  > **Samsung**  > **S Health** .
2. Follow the prompts to get started:
 - Read the introduction and tap **Start**.
 - Read and agree to the terms and conditions, and then tap **Next**.
 - Sign in to your Samsung account if you have not already done so. You must sign in to a Samsung account to set and save goals, and use other advanced S Health features.
 - Follow the onscreen instructions to enter information about yourself, and then tap **Start**.
3. Use S Health to track your health activities:
 - **Pedometer**: Count the number of steps you take. Tap **Start** to start counting. You can pause counting and then tap **Start** to begin again. If you signed in to your Samsung account, you can set goals, track your progress, and share your results.
 - **SpO₂**: Measure the amount of oxygen in your blood.
 - **Stress**: Measure your stress level using your heart rate variable.
 - **Running**: Use S Health as a pace-setter while running.
 - **Heart rate**: Measure your heart rate, using the heart rate sensor on the back of your phone (next to the Camera flash). Place your finger over the sensor, and then tap the screen to start. Hold your finger on the sensor, and keep still until the sensor reports your heart rate.
 - **Coach**: Coach by Cigna provides general information and features designed to help you to manage your overall well-being.
 - **Partner apps**: Manage additional S health-compatible apps you install here.

Before You Start Exercising

This app can be used to monitor your exercise. While moderate physical activity, such as brisk walking, is safe for most people, health experts suggest that you talk with your doctor before you start an exercise program, particularly if you have any of the following conditions:

- Heart disease;
- Asthma or lung disease;
- Diabetes, or liver or kidney disease;
- Arthritis.

You should also check with your doctor if you have symptoms suggestive of heart, lung, or other serious disease, such as:

- Pain or discomfort in your chest, neck, jaw, or arms during physical activity;
- Dizziness or loss of consciousness;
- Shortness of breath with mild exertion or at rest, or when lying down or going to bed;
- Ankle swelling, especially at night;
- A heart murmur or a rapid or pronounced heartbeat;
- Muscle pain when walking upstairs or up a hill that goes away when you rest.

Finally, the American College of Sports Medicine recommends that you see your doctor before engaging in vigorous exercise if two or more of the following apply:

- You are a man older than age 45 or a woman older than age 55;
- You have a family history of heart disease before age 55;
- You smoke or quit smoking in the past six months;
- You have not exercised for three months or more;
- You are overweight or obese;
- You have high blood pressure or high cholesterol;
- You have impaired glucose tolerance, also called pre-diabetes.

When in Doubt – Check it Out

If you are unsure of your health status, have several health problems, or are pregnant, you should speak with your doctor before starting a new exercise program. Working with your doctor ahead of time is a good way to plan an exercise program that is right and safe for you. Consider it the first step on your path to physical fitness.

Samsung+

Get live help, discover new features, and unlock promotions for your Samsung device.

- From home, tap **Apps**  > **Samsung**  > **Samsung+** .

Sprint Fun & Games

Download new apps and games from Sprint.



- From home, tap **Apps**  > **Sprint**  > **Sprint Fun & Games** .

Sprint Music Plus

Purchase, download, and play music, ringtones, and ringback tones for your phone.

Install the Sprint Music Plus App

Before you use Sprint Music Plus on your phone, you must download and install the app.



1. From home, tap **Apps**  > **Sprint**  > **Sprint Music Plus** .
2. Tap **Install** and follow the prompts to download and install the app.
3. When the download has completed, tap **Open**.

❖ The app opens.

Access Sprint Music Plus

1. From home, tap **Apps**  > **Sprint**  > **Sprint Music Plus** .

❖ The app opens.

- The first time you use the app, tap **Accept** to agree to the Premium Services Terms of Use.
2. Tap a store option from the main page (**Ringbacks Store**, **Music Store**, or **Ringtones Store**), or tap **More options**  > **Music** (under **Library**) to access your music.
 - Tap the navigation tools to skip ahead or rewind. Tap **More options**  at any time to see additional options.
 - For more information, tap **Menu**  > **Settings** > **About** or **Help**.

Note: If you have loaded music on to your phone from your computer (see [Transfer Files between Your Phone and a Computer](#)), you will need to sync your music to listen to it through Sprint Music Plus. From the Sprint Music Plus app, tap  > **Settings** > **Synchronize your music library**. Once synced, you will see your music in the library.

Purchase and Download Music from the Sprint Music Plus Store

From the Sprint Music Plus Store, you can shop for songs to purchase and download to your phone.

1. From home, tap **Apps**  > **Sprint**  > **Sprint Music Plus**  > **Music Store**.

❖ The app will open and display the Music Store.

2. Enter a song or artist in the search field or browse through options in the tabs in the center of the screen.
3. Tap a song to select it.

❖ The song information screen is displayed.

4. Follow the prompts to preview or purchase the song. Tap **More options**  at any time to display the Sprint Music Plus menu.

Tip: For ringtones or ringback tones, tap **Ringtone Store** or **Ringbacks Store** from the Sprint Music Plus main menu.

Sprint TV & Movies



Use Sprint TV & Movies to watch live TV and access movies and other on demand entertainment on the go.

Note: Coverage not available everywhere. Content and lineup subject to change. Select channels also available for casual usage.

Your Sprint TV Channel Options

The Sprint TV application offers a wide variety of accessible channels. Subscription options include comprehensive basic packages as well as a full menu of “a la carte” channels.



Watch TV

1. From home, tap **Apps**  > **Sprint**  > **Sprint TV & Movies** .
2. Follow the prompts to browse categories and find programs.
 - Depending on your settings, your phone may prompt you to accept a data connection.
 - Browse horizontally through the category options in the center of the screen to see what's available. For quick access, touch a featured item in the center of the screen or select a live channel from the bottom bar.
 - Scroll up and down in a category list and then touch a clip or channel to view the program.

Note: The first time you access a channel that requires a subscription, you will be prompted to purchase access. Touch **Subscribe** to purchase access, or touch **Preview** to see a preview of the selected channel.

Sprint Zone

Access your Sprint account, get device information and help, find recommended apps, and more.

1. From home, tap **Apps**  > **Sprint Zone** .
2. Tap **My Account** to sign in to and manage your Sprint account, **Support** to get help with your device or service, **Sprint News** to learn the latest Sprint information, or **Network** to see or test your current data connectivity.

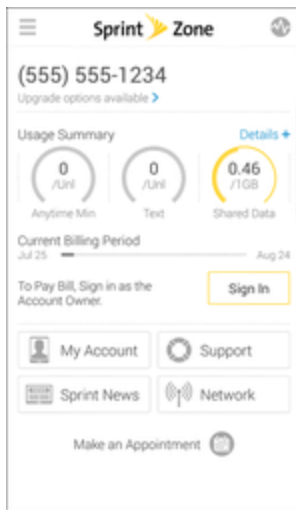



Note: Sprint Zone categories and options are subject to change. Check back frequently for new content and updates.

YouTube

View and upload YouTube videos from your device.



View YouTube Videos

You can use the YouTube app to view videos on YouTube even if you aren't signed in to a YouTube account.

1. From home, tap **Apps**  > **Google**  > **YouTube** .
- ❖ The YouTube app launches.
 - If you are prompted to provide confirmation to use the site, follow the prompts to continue.
2. Search through the YouTube channels and tap a video you want to see.
 - ❖ The video plays on your phone screen.
 - Tap the screen to pause or resume play while watching.

Post a Video to YouTube

You can post videos to your YouTube account from your phone. Before posting, you must set up a YouTube account and sign in to it on your phone.

1. From home, tap **Apps**  > **Google**  > **YouTube** .
- ❖ The YouTube app launches.

2. Tap **Account** .

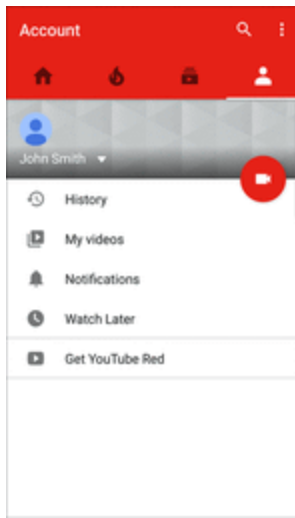

❖ The Account menu appears.

3. Tap **Add** .

4. Find a stored video and tap the thumbnail to select it.

- Enter a title, description, and tags, and select a privacy setting.

5. Tap **Upload** .

❖ The video is uploaded to your YouTube channel.

Settings

The topics in this section will cover your phone's settings menus and options. For an overview of the settings menu, see [Basic Settings](#).

Connections Settings

The following topics introduce your phone's basic settings menus and cover your phone's Connections settings options.

Basic Settings

From the home screen, tap **Apps**  > **Settings**  to access your phone's settings menu.

The table below outlines the top-level settings categories.

Category	Description
Wi-Fi Calling	Enable and set Wi-Fi calling options.
Wi-Fi	Enable and set Wi-Fi options.
Bluetooth	Enable Bluetooth connections.
Device visibility	Make your device visible to allow other devices to find it and share content.
Data usage	Check your phone's data usage.
Airplane mode	Turn Airplane mode on or off.
NFC and payment	Enable Near-Field Communication (NFC) functions, including Tap and pay services.
Mobile networks	View and configure your mobile network connections and settings.
Location	Select the method used to estimate your location. You can also view the apps that have requested your location and review their history logs.
More connection settings	Set wireless and network functions, including scanning for nearby devices, using printing services, using MirrorLink, and setting up a Virtual Private Network (VPN).
Hotspot and Tethering	Use the Mobile Hotspot feature and tethering feature to share your phone's data connection with other devices using Wi-Fi, Bluetooth, or USB connection.
Sounds	Configure ringtone and vibration settings.
Notifications	Select which apps can send you alerts, notifications, sounds, and vibrations.
Display	Set display features, font, brightness, etc.
Wallpapers and themes	Set wallpaper for the home and lock screens, and select visual themes for your phone.
Advanced features	Configure features for the S Pen, playing games, using the phone with one hand, screen capture gestures, and more.

Category	Description
Device maintenance	See an overview of the status of your device's battery, storage, RAM, and device security.
Applications	Manage default apps, default apps, and system processes.
Lock screen and security	Set your phone's lock screen options. Set security features such as device administrators, encryption, and trusted credentials.
Cloud and accounts	Set up and manage accounts, back up and sync your data, reset your phone, and transfer content from old devices.
Google	Configure your device's Google settings.
Accessibility	Set accessibility options such as screen magnification, hearing aid compatibility, etc.
General management	Configure your phone's language and input options, set the date and time, and report diagnostic information.
System Update	Update your system's software, PRL, and Profile.
Help	View tips and guidelines for using your phone.
About device	View device status, legal information, and hardware information about your device.

Access Settings

1. From home, tap **Apps**  > **Settings** .

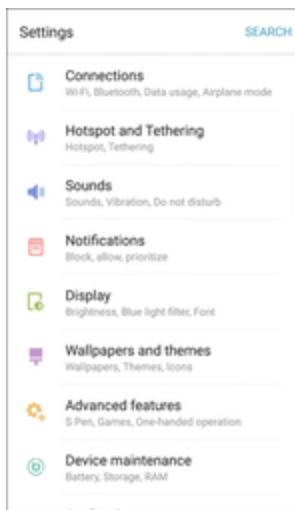

- ❖ The settings menu opens.
2. Select categories and then select your settings options.
 - ❖ Settings are made and applied.

Tip: You can also access settings from the notification panel. Pull down the status bar and tap **Settings** .

Connection Settings Menu

This topic provides an overview of your phone's connections settings menu options.

Access Connection Settings

- From the home screen, tap **Apps**  > **Settings**  > **Connections** .

The table below outlines your Connection settings.

Category	Description
Wi-Fi	Enable and set Wi-Fi options.
Bluetooth	Enable Bluetooth connections.
Device visibility	Make your device visible to allow other devices to find it and share content.
Data usage	Check your phone's data usage.
Airplane mode	Turn Airplane mode on or off.
NFC and payment	Enable Near-Field Communication (NFC) functions, including Tap and pay services.
Mobile networks	View and configure your mobile network connections and settings.
Location	Enable one or more location services.
More connection settings	Set wireless and network functions, including scanning for nearby devices, using printing services, and setting up a Virtual Private Network (VPN).

Wi-Fi Settings Menu

The Wi-Fi settings menu lets you turn Wi-Fi on or off, set up and connect to available Wi-Fi networks, and configure advanced Wi-Fi options.

For more information about Wi-Fi settings, see [Wi-Fi](#).

1. From home, tap **Apps**  > **Settings**  > **Connections** .

2. Tap **Wi-Fi**.

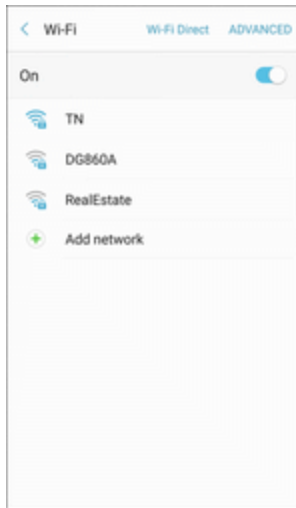

❖ The Wi-Fi settings menu appears.

3. Tap **On/Off** to turn Wi-Fi on.

❖ Wi-Fi is enabled. You will see the names and security settings of in-range Wi-Fi networks.

- To disable Wi-Fi, tap **On/Off** again.

4. Tap a Wi-Fi network, enter the password, and tap **Connect**.

❖ Your phone is connected to the selected Wi-Fi network.

5. Configure your Wi-Fi settings.

❖ Your Wi-Fi settings changes are saved.

- The password, for a household wireless LAN router, is sometimes found on a sticker on the router (WEP, WPA, KEY, etc.). Contact the router manufacturer for information. For the password for a public wireless LAN, check with user's service provider.
- Entering a password is not required if an access point is not security protected.

Connect to a Wi-Fi Network Using WPS

Wi-Fi Protected Setup (WPS) is a network security standard that allows you to easily secure a wireless network connection between your phone and a router.

To connect using a WPS button:

1. From Wi-Fi settings, tap **Advanced > WPS push button**.
2. Press the WPS button on your router.
3. Follow the prompts to complete the connection.

To connect using a Personal Identification Number (PIN):

1. From Wi-Fi settings, tap **Advanced** > **WPS PIN entry**.
2. Enter the PIN displayed on your router.
3. Follow the prompts to complete the connection.

Smart Network Switch

Smart network switch lets your phone automatically switch to the wireless network data connection when the current Wi-Fi connection is unstable.

1. From the Wi-Fi settings menu, tap **Advanced** > **Smart network switch**.
2. Tap **On/Off** to enable the feature.

Advanced Wi-Fi Settings

The advanced Wi-Fi settings menu lets you set up and manage wireless access points.

- From the Wi-Fi menu, tap **Advanced** to access Wi-Fi settings:
 - **Smart network switch**: Connect automatically to a mobile network connection when the Wi-Fi connection is unstable.
 - **Network notification**: Receive notifications when open networks in range are detected.
 - **Hotspot 2.0**: Automatically connect to Wi-Fi access points that support Hotspot 2.0.
 - **Manage networks**: Manage your saved Wi-Fi networks.
 - **WPS push button**: Set up a connection to a WPS (Wi-Fi Protected Setup) router or other equipment.
 - **WPS PIN entry**: View the PIN used by your device to set up a PIN-secured connection to a Wi-Fi router or other equipment (not configurable).
 - **Keep Wi-Fi on during sleep**: Specify when to disconnect from Wi-Fi.
 - **Install network certificates**: Install authentication certificates.
 - **MAC address**: View your device's MAC address, which is required when connecting to some secured networks (not configurable).
 - **IP address**: View your device's IP address (not configurable).

Bluetooth Settings



Your phone's Bluetooth capabilities let you use wireless headsets, send and receive pictures and files, and more. For details on your phone's Bluetooth usage, see [Bluetooth](#).



1. From home, tap **Apps**  > **Settings**  > **Connections** .
2. Tap **Bluetooth**.



❖ The Bluetooth settings open.



Bluetooth Settings Operations

- **Enable Bluetooth:** From Bluetooth settings, tap **On/Off**.
 - When enabled, confirmation appears for your phone to be discoverable by other devices. Follow the prompts.
- **Change your phone name:** From Bluetooth settings, tap **More options**  > **Rename device**, enter a new name, and tap **Done**.
 - This changes the name of your phone as seen by other devices.
- **Pairing Bluetooth devices:** Make sure the other devices are set to be discovered. From Bluetooth settings, tap the device name in “Available devices” and follow the prompts.
 - Depending on the device, you may be required to enter or accept a passkey.
 - If the target device does not appear, tap **Scan** to search again.
 - This setting is available when Bluetooth is enabled.
- **Change the name of a paired device:** From Bluetooth settings, tap **Settings**  next to a paired device name, tap **Rename**, enter a new name, and tap **OK**.
 - Emoji cannot be used in a device name.
 - This setting is available when Bluetooth is enabled.

- **Canceling pairing:** From Bluetooth settings, tap **Settings**  next to a paired device name, and then tap **Unpair**.
 - This setting is available when Bluetooth is enabled.
- **Enable service from paired device:** From Bluetooth settings, tap **Settings**  next to a paired device name, and then tap the listing under **Profiles**.
 - If a confirmation prompt appears, follow the prompts.
 - This setting is available when Bluetooth is enabled.
 - This setting is available when the paired device is providing a service.
 - Tap the setting to toggle **On/Off**.
- **Search for other devices:** From Bluetooth settings, tap **Scan**.
 - This setting is available when Bluetooth is enabled.
- **Check files received using Bluetooth transfer:** From Bluetooth settings, tap **More options**  > **Received files**, and then follow the prompts.

Device Visibility

Make your device visible to allow other devices to find it and share content.

1. From home, tap **Apps**  > **Settings**  > **Connections** .
2. Tap **Device visibility**, and then tap **On/Off** to turn on visibility.



Data Usage Settings

The data usage menu lets you view your phone's mobile and Wi-Fi data usage, set data limits, restrict hotspot usage, and more.

1. From home, tap **Apps**  > **Settings**  > **Connections** .
2. Tap **Data usage**.



❖ The data usage window opens.

3. Data usage settings operations:

- **Data usage cycle:** Tap the drop-down menu, and then choose a time period for data usage. Data usage for the period is displayed on the graph, along with usage by application at the bottom of the screen.
- **Mobile data:** Enable or disable mobile data.
- **Limit mobile data limit:** Your mobile data connection is turned off when the specified limit is reached.
- **Alert me about data usage:** Receive an alert when your mobile data usage reaches the amount you selected.
- **By application:** View data usage by application.

4. Tap **More** for the following options:

- **Restrict background data:** Restrict some apps and services from working unless you are connected to a Wi-Fi network.
- **Show/Hide Wi-Fi usage:** Display or hide a Wi-Fi tab that shows Wi-Fi usage.

- **Restrict networks:** Select Wi-Fi networks that are mobile hotspots. You can restrict apps from using these networks, and you can configure apps to warn you before using these networks for large downloads.
- **Help:** View help topics for data usage.

Airplane Mode

When you enable Airplane mode, your phone disconnects from all networks, meaning you cannot make calls, send or receive messages, or access the Internet. It also turns off other connectivity features, such as Wi-Fi and Bluetooth.

While in airplane mode, you can use other features of your phone, such as playing music, watching videos, or using other applications.

To use Wi-Fi and Bluetooth after enabling Airplane mode, turn them on either in Settings or on the notification panel.

1. From home, tap **Apps**  > **Settings**  > **Connections** .
2. Tap **Airplane mode**.



3. Tap **On/Off** to enable Airplane mode.

Note: You can also enable or disable Airplane Mode through the notification panel quick settings (drag down the status bar and tap **Airplane mode** > **Turn on**).

NFC and Payment

NFC and payment uses the Near-Field Communication (NFC) feature of your phone. You can send information using NFC, including payment through mobile payment services at businesses that support this function.

Access NFC and Payment

1. From home, tap **Apps**  > **Settings**  > **Connections** .
2. Tap **NFC and payment**.

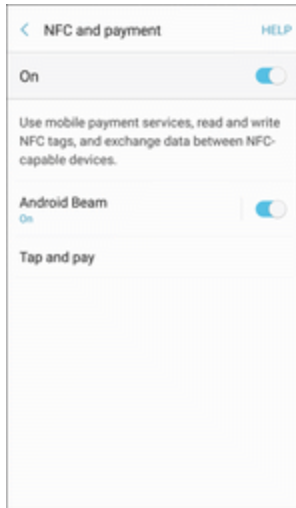

3. Tap settings to configure them.
 - ❖ Your settings are saved and implemented.

Enable NFC and Android Beam

1. From home, tap **Apps**  > **Settings**  > **Connections** .
2. Tap **NFC and payment**.

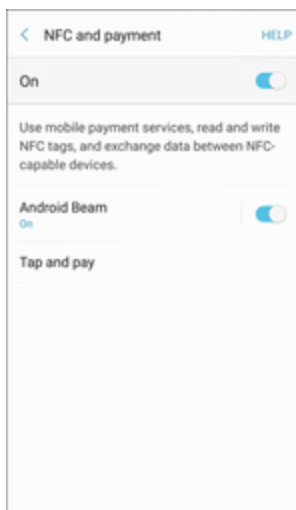

3. Tap **On/Off** to enable NFC.
4. Tap **Android Beam**, and then tap **On/Off** to enable Android Beam.

❖ NFC and Android Beam are enabled.

Tap and Pay

With your phone and a payment app (such as Samsung Pay), you can use your phone to pay for items by tapping it to an item at the point-of-purchase. You must have a payment app set up on your phone to use it with Tap and Pay.

Note: Tap and Pay payment apps may be downloaded from Google Play store. See [Google Play Store](#).

1. From home, tap **Apps**  > **Settings**  > **Connections** .
2. Tap **NFC and payment**.

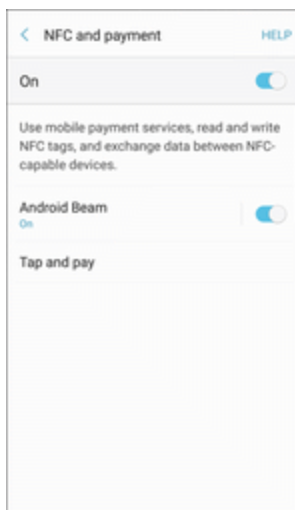

3. Tap **Tap and pay**.

- ❖ Tap and pay payment apps you have installed are display.
- Available options depend on the payment app(s) you have set up on your phone.

Mobile Networks Settings

The Mobile networks settings menu allows you to configure your mobile network connections.

Set options for network selection and data service.

1. From home, tap **Apps**  > **Settings**  > **Connections** .
2. Tap **Mobile networks**.



3. Configure options:

- **Data roaming:** When you are outside your home network area, your phone can still connect to other networks that your provider supports using roaming. There may be additional costs for accessing networks while roaming, so you may want to control your phone's roaming behavior with Roaming settings.
 - **Roaming network:** Select a roaming default. Choose **Home only**, to only connect to the Sprint network, or **Automatic** to allow connections to Sprint's partner networks, when available.
 - **Roaming guard:** Choose options for displaying an onscreen roaming notice for certain functions. Enable or disable roaming notices for Voice and Data for Domestic use, Voice, Data and Outgoing text message for International networks, and Voice, Data and Outgoing text message for GSM networks (if supported by your phone).
 - **Roaming settings:** Enable or disable roaming options, including Voice and Data for Domestic and International networks, and Data for GSM networks (if supported by your phone).
- **Network mode:** Choose a preferred network mode. Available options depend on your phone's features, but may include: CDMA, LTE / CDMA, GSM / UMTS, and Automatic (the recommended setting).
- **Access Point Names:** View, configure, and add access point names (APNs) for your phone's data connection.
- **Network operators:** View mobile network operator information for international GSM networks.

Location Settings

Some apps, such as Google Maps, may require one or more location services be turned on for full functionality.

Locating Method

Before using any features that require location assistance, you must enable your device's location services.

1. From home, tap **Apps**  > **Settings**  > **Connections** .
2. Tap **Location**.

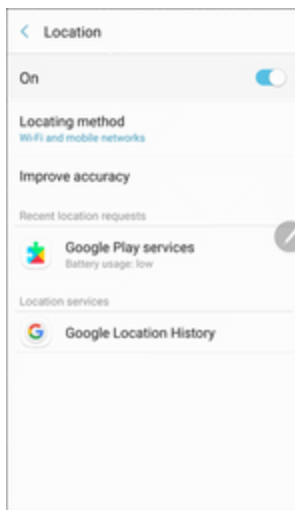

3. Tap **On/Off** to turn on Location services.
4. Tap **Locating method** to select how your location is determined:
 - **GPS, Wi-Fi, and mobile networks**: Use GPS, Wi-Fi, and mobile networks.
 - **Wi-Fi and mobile networks**: Use Wi-Fi and mobile networks (no GPS).
 - **GPS only**: Use GPS only.
5. Tap **Improve accuracy** to use other connections for determining your location:
 - **Wi-Fi scanning**: Allow apps and services to scan for Wi-Fi networks automatically, even when Wi-Fi is turned off.
 - **Bluetooth scanning**: Allow apps to scan for and connect to nearby devices automatically through Bluetooth, even when Bluetooth is turned off.

Recent Location Requests

Apps that have requested your location are listed under Recent location requests.

1. From home, tap **Apps**  > **Settings**  > **Connections** .
2. Tap **Location**.

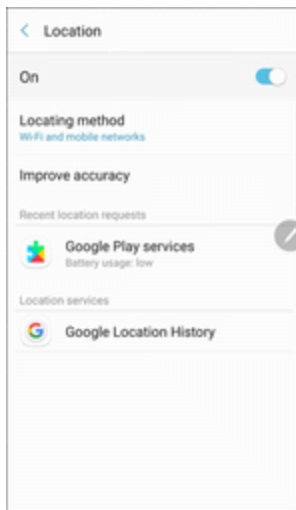

3. Tap **On/Off** to turn on Location services.
4. Tap an entry under **Recent location requests** to view the app's settings.

Location Services

Google uses Location History to store and use your device's most recent location data. Google apps, such as Google Maps, can use this data to improve your search results based on places that you have visited.

1. From home, tap **Apps**  > **Settings**  > **Connections** .

2. Tap **Location**.

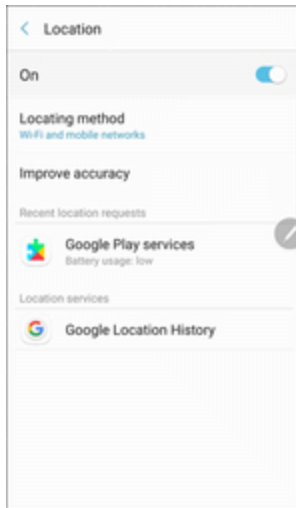

3. Tap **On/Off** to turn on Location services.

4. Tap **Google Location History** and sign in to your Google Account for more options.

More Connection Settings

The more connection settings menu provides access to additional connection options, such as Nearby device scanning, Printing, MirrorLink, and VPN.

More Connection Settings Options

Setting	Description
Nearby device scanning	Scan for and connect to nearby devices.
Printing	Set up printers to print from your phone.
MirrorLink	Mirror your phone's display on your car's entertainment and information screen using a USB connection.
VPN	Add a Virtual Private Network (VPN)

Access More Connection Settings Options

1. From home, tap **Apps**  > **Settings**  > **Connections** .

2. Tap **More connection settings**.





3. Set items.

❖ Your settings are saved and implemented.

Nearby Device Scanning

Scan for and connect to nearby devices. You will receive notifications when there are available devices to connect to.

1. From home, tap **Apps**  > **Settings**  > **Connections**  > **More connection settings**.
2. Tap **Nearby device scanning**.



❖ The Nearby device scanning screen displays.



3. Tap **On/Off** to enable the feature.

Printing

You can print from your phone, using Wi-Fi, to an optional compatible printer (not included). Your phone and the optional printer must be connected to the same Wi-Fi network.



Add a Printer

Before you can print to a printer, you must add and set it up on your phone. You will need to know the IP address of the printer; consult the printer's documentation for this information.

1. From home, tap **Apps**  > **Settings**  > **Connections**  > **More connection settings**.
2. Tap **Printing**.





❖ The Printing settings screen displays.

3. From the Printing settings screen, tap **Download plug-in**.
4. Follow the prompts to download and install a print driver from the Google Play store.
5. Choose a print service from the list, and then tap **On/Off** to turn the service on or off. The service must be on to add a printer.
6. Tap **More options**  > **Add printer** > **Add printer** (or  depending on the plug-in), and then enter a name and the IP address of the printer.

Set Up a Printer

Add a printer to a print service and configure settings.

Note: Below settings are examples only. Available settings will differ depending on the type of print service and printer you are using.

1. From the Printing settings screen, select a print service from the list.
2. Tap **On/Off** to turn the service on. The service must be on to add a printer.
3. Tap **More options**  > **Add printer** and follow the prompts to add a printer.
4. Tap **More options**  > **Printer settings** to configure printer options. Available options may vary depending on the type of printer, and not all printers support all options.

Virtual Private Networks (VPN)

From your phone, you can add, set up, and manage virtual private networks (VPNs) that allow you to connect and access resources inside a secured local network, such as your corporate network.



Prepare Your Phone for VPN Connection

Depending on the type of VPN you are using at work, you may be required to enter your login credentials or install security certificates before you can connect to your company's local network. You can get this information from your network administrator.

Before you can initiate a VPN connection, your phone must first establish a Wi-Fi or data connection. For information about setting up and using these connections on your phone, see [Browser](#) and [Turn Wi-Fi On and Connect to a Wireless Network](#).

Set Up Secure Credential Storage

If your network administrator instructs you to download and install security certificates, you must first set up the phone's secure credential storage before setting up a VPN.

1. From home, tap **Apps**  > **Settings**  > **Lock screen and security**.
2. Tap **Screen lock type** > **Pattern, PIN, Password, Fingerprints, or Irises**.

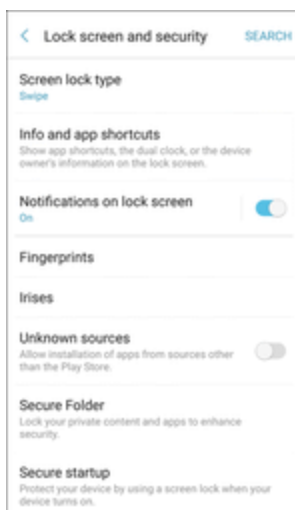

3. Follow the prompts to set up your secure screen lock.
4. Tap **Back**  to return to the main settings menu, and then tap **Other security settings**.

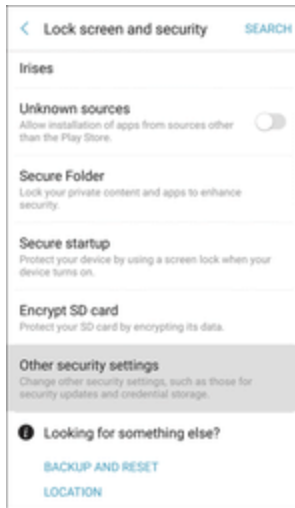

5. Tap **Trusted credentials** and then tap your preferred system and user credentials.

 Your secure credentials storage is set.

You can then download and install the certificates needed to access your local network. Your network administrator can tell you how to do this.

Add a VPN Connection

Use the VPN settings menu to add a VPN connection to your phone.

1. From home, tap **Apps**  > **Settings**  > **Connections**  > **More connection settings**.

2. Tap **VPN**.

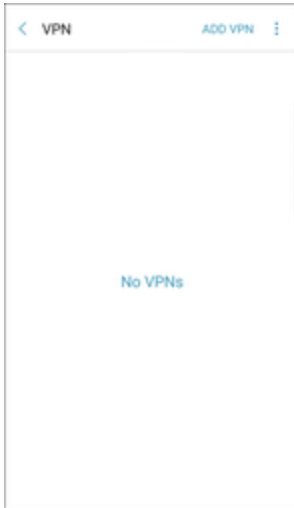

❖ The VPN settings window appears.

3. Tap **Add VPN**, and then enter the information for the VPN you want to add.

- Information may include Name, Type, Server address, PPP encryption (MPPE), and advanced options.
- Set up all options according to the security details you have obtained from your network administrator.

4. Tap **Save**.

❖ Your VPN is added to the VPNs section of the VPN settings window.

Connect to or Disconnect from a VPN

Once you have set up a VPN connection, connecting and disconnecting from the VPN is easy.

To access the VPN settings window:

1. From home, tap **Apps**  > **Settings**  > **Connections**.

2. Tap **More connection settings > VPN**.



❖ The VPN settings window appears.

Connect to a VPN

1. From the VPNs section of the VPN setting window, tap the VPN that you want to connect to.
2. When prompted, enter your login credentials, and then tap **Connect**.

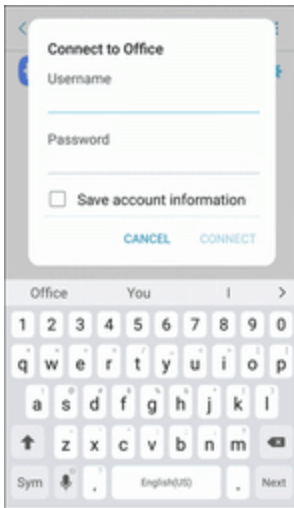

❖ You will connect to the selected VPN.

- When you are connected, a VPN connected icon appears in the notification area.
3. Open the Web browser to access resources such as intranet sites on your corporate network.

Disconnect from a VPN

1. Pull down the status bar to open the notification panel.

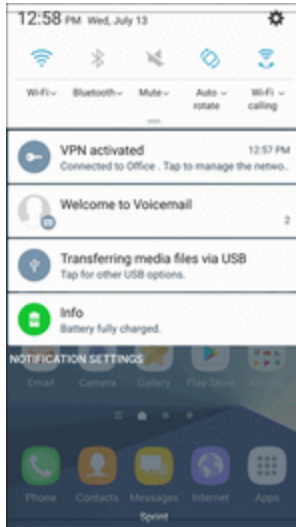

2. Tap the VPN connection to return to the VPN settings window.
3. Tap the VPN connection to disconnect from it.

❖ Your phone disconnects from the VPN.

- When your phone has disconnected from the VPN, you will see a VPN disconnected icon in the notification area of the status bar.

Wi-Fi Calling Settings



The Wi-Fi Calling settings menu lets you set your Wi-Fi Calling options, including updating your 9-1-1 information. For information about setting up Wi-Fi Calling, see [Wi-Fi Calling](#).

Note: Wi-Fi Calling may not be available on your phone at launch.

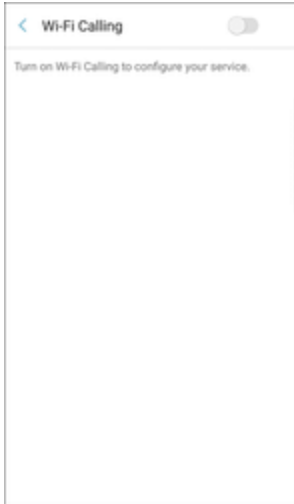
1. From home, tap **Apps**  > **Settings**  > **Wi-Fi Calling**.



2. Follow the prompts to change your Wi-Fi Calling settings.

- ❖ When Wi-Fi Calling is set up, you will see **Wi-Fi calling enabled**  in the status bar when Wi-Fi Calling is active, or **Wi-Fi calling disabled**  if it is set up but you are not currently connected to a Wi-Fi network.

Tip: For more information about Wi-Fi Calling, visit this [FAQ link at sprint.com/support](https://sprint.com/support).

Hotspot and Tethering Settings

Use Mobile hotspot and tethering to share your device's Internet connection with other devices.

For more information, see [Hotspot](#).

Hotspot Settings

Use Hotspot to share your device's Internet connection with other devices

1. From home, tap **Apps**  > **Settings** .

2. Tap **Hotspot and Tethering**  > **Hotspot**.

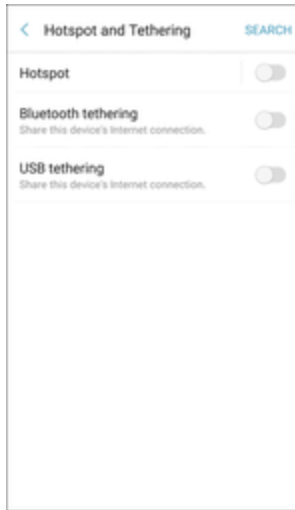

❖ The Hotspot window opens.





3. Tap **On/Off** to turn Hotspot on.

❖ Hotspot is enabled.

- To disable Hotspot, tap **On/Off** again.

Advanced Hotspot Settings



The hotspot settings menu lets you configure advanced options.

- **Set Network SSID:** From the Hotspot window, tap **More options**  > **Configure Hotspot** > **Network name**, enter a name for your hotspot, and then tap **Save**.
- **Hide your Hotspot:** From the Hotspot window, tap **More options**  > **Configure Hotspot** > **Hide my device** to make your Mobile hotspot invisible to other Wi-Fi devices during a scan. When hidden, other devices can still connect to your Mobile hotspot, but have to set up the connection manually with your Network SSID and Password.
- **Set Hotspot security:** From the Hotspot window, tap **More options**  > **Configure Hotspot** > **Security**, select a security settings option, and then tap **Save**.
- **Set Hotspot password:** From the Hotspot window, tap **More options**  > **Configure Hotspot** > **Password**, enter a password, and then tap **Save**.
- **Set allowed devices:** To select which devices are allowed to connect to the Hotspot, in the Hotspot window, tap **More options**  > **Allowed devices** > **Add**, enter a device name and MAC address, and then tap **Add**.
 - To remove allowed devices, tap **Delete**.

- **Set Hotspot Timeout Settings:** From the Hotspot window, tap **More options**  > **Timeout settings**, select an option, and tap **OK**.
 - IP Address appears below “IP Address”.

Using Wi-Fi Sharing

Your Wi-Fi network may be shared with other devices. Be aware that your device may switch between your saved Wi-Fi networks without notice.

1. From home, tap **Apps**  > **Settings** .
2. Tap **Hotspot and Tethering**  > **Hotspot**.



❖ The Hotspot window opens.



3. Tap **More** > **Wi-Fi sharing** for the following options:
 - Turn on Wi-Fi sharing
 - Turn off Wi-Fi sharing

Tethering Settings

Use Tethering to share your device’s Internet connection with a computer that connects to your device using a USB cable or by Bluetooth.

For more information, see [Tethering](#).

Note: Using the tethering feature consumes battery power and uses data services.

1. From home, tap **Apps**  > **Settings** .
2. Tap **Hotspot and Tethering** .

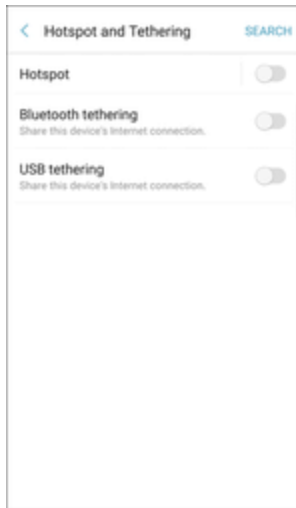

❖ The Hotspot and tethering window opens.

3. Choose an option
 - **Bluetooth tethering:** Pair your device with the computer using Bluetooth. Consult the computer's documentation for more information about configuring your computer to pair using Bluetooth. Tap **Bluetooth tethering** to turn tethering on.
 - **USB tethering:** Connect the computer to your phone using a USB cable, and then tap **USB tethering** to turn tethering on.

Device Settings

The following topics outline the device settings options available on your phone, including sounds, display, gestures, applications, and more.

Sounds Settings

The following topics cover your phone's Sounds settings options.

Access Sounds Settings



- From the home screen, tap **Apps**  > **Settings**  > **Sounds** .

The table below outlines your Sounds settings.

Category	Description
Sound mode	Set the sound mode for the phone. <ul style="list-style-type: none">■ Sound: Your phone uses the sounds, vibrations, and volume levels you have chosen in Sound settings for notifications and alerts.■ Vibrate: Your phone vibrates for notifications and alerts. This uses the Vibration intensity you choose in Sound settings.■ Mute: Your phone plays no sounds or vibrations. Onscreen reminders will still occur.
Vibrate while ringing	Set your device to vibrate in addition to ringing when you receive a call.
Volume	Set volume for ringtones, media, system features, etc.
Vibration intensity	Set the amount of vibration for incoming calls, notifications, and haptic feedback.
Ringtone	Set your ringtones and notification sounds for your phone, apps, keypad, and other features.
Vibration pattern	Choose from preset vibration patterns or create your own pattern.
Notification sounds	Choose a sound for notifications, such as for new messages and event reminders.
Do not disturb	Configure the Do not disturb feature to mute calls and alerts at will or on a schedule, as well as set exceptions.
Touch sounds	Play tones when you touch or tap the screen to make selections.
Screen lock sounds	Play sounds when locking or unlocking the screen.
Charging sound	Play a sound when a charger is connected.

Category	Description
Emergency tone	Sound an alert, vibrate, or stay silent when an emergency alert is received.
Charging sound	Play a sound when a charger is connected.
Vibration feedback	Set the phone to vibrate when the Back key or Recent apps key are tapped, and for other actions.
Dialing keypad tones	Play tone when the dialing keypad is tapped.
Keyboard sound	Play a sound when the Samsung keyboard is tapped.
Keyboard vibration	Set the phone to vibrate when the Samsung keyboard is tapped.
Sound quality and effects	Set sound quality and sound effects for your phone.

Access Sound Settings

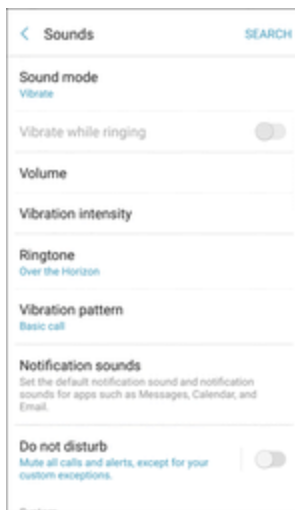

1. From home, tap **Apps**  > **Settings** .
2. Tap **Sounds** .



3. Set your sound and vibration options.
 - ❖ Your sound and vibration settings are saved and applied.

Sound Mode

You can switch between sound modes, while preserving the individual sound settings you have made.

1. From home, tap **Apps**  > **Settings** .
2. Tap **Sounds** .

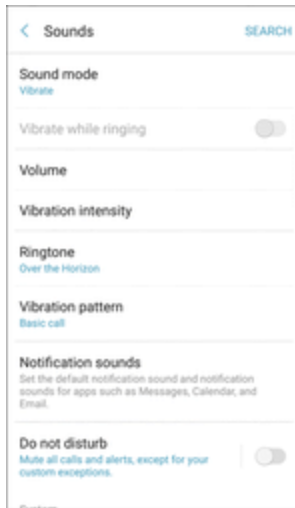

3. Tap **Sound mode**, and then choose a mode:
 - **Sound:** Your phone uses the sounds, vibrations, and volume levels you have chosen in Sound settings for notifications and alerts.
 - **Vibrate:** Your phone vibrates for notifications and alerts. This uses the Vibration intensity you choose in Sound settings.
 - **Mute:** Your phone plays no sounds or vibrations. Onscreen reminders will still occur.

Vibrate While Ringing

Set the phone to vibrate while ringing.

1. From home, tap **Apps**  > **Settings** .

2. Tap **Sounds** .

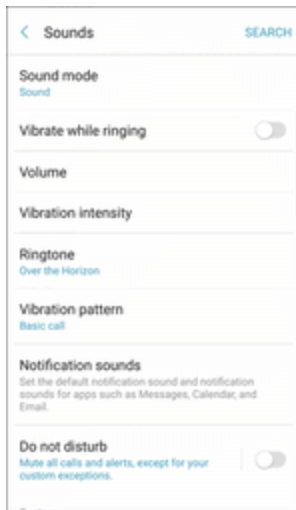



3. Tap **On/Off** next to Vibrate while ringing to enable the feature.

Volume

Set the system volume level, and set default volume for call ringtones, notifications, and other media.

Note: You can also set System volume from the home screen by pressing the **Volume** key.

1. From home, tap **Apps**  > **Settings** .
2. Tap **Sounds** .

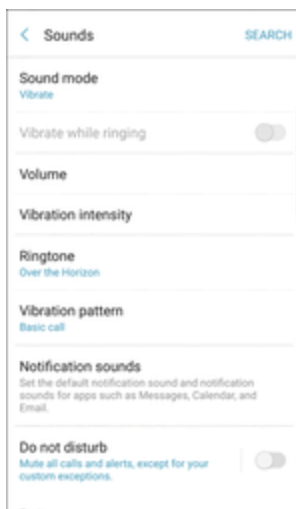



3. Tap **Volume** and then drag the sliders to set the default volume for:

- Ringtone
- Media
- Notifications
- System

Vibration Intensity

Set the vibration intensity for incoming calls, notifications, and vibration feedback.

1. From home, tap **Apps**  > **Settings** .
2. Tap **Sounds** .

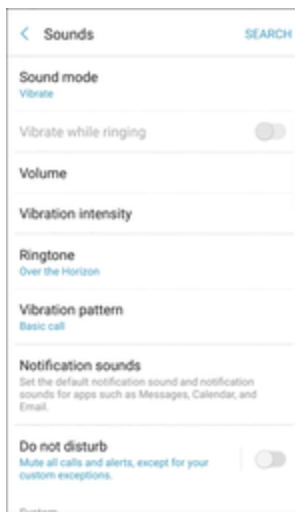

3. Tap **Vibration intensity**.
4. Use the sliders to set the intensity of vibration for:
 - **Incoming call:** The phone vibrates when receiving an incoming call.
 - **Notifications:** The phone vibrates when receiving notifications.
 - **Vibration feedback:** The phone vibrates when soft keys are tapped and for certain software actions.

Ringtones and Sounds

Choose a ringtone for incoming calls.

1. From home, tap **Apps**  > **Settings** .

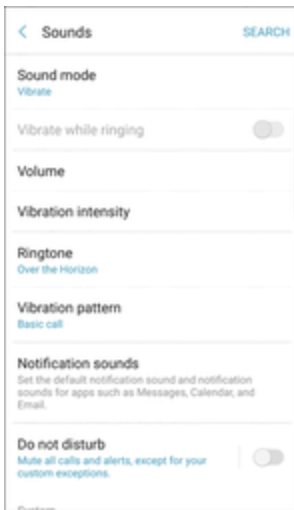

2. Tap **Sounds** .





3. Tap **Ringtone** to select a default ringtone.

Add a Ringtone

When you select a ringtone, you can add a custom ringtone.

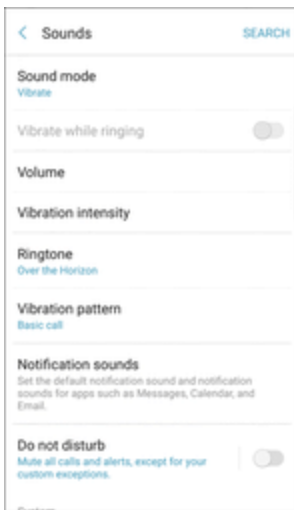
1. From home, tap **Apps**  > **Settings** .
2. Tap **Sounds** .



3. Tap **Ringtone**, scroll to the bottom of the list, and then tap **Add from device storage** .
4. Select a source (OneDrive[®] or Sound picker) for the ringtone.

- ❖ You will see a list of compatible songs or audio files. To load music on your phone, see [Transfer Files between Your Phone and a Computer](#).



5. Tap a song to hear a preview, and then tap **Done** to save it as a ringtone.

- ❖ The new ringtone is saved to the list and will be available to be assigned as a default ringtone or as a ringtone for individual contacts, groups, etc.

Tip: When choosing music for a ringtone, select the **Highlights only** checkbox to allow the system to select what part of the song to use. Clear the checkbox to play the song from the beginning.

Vibration Pattern

Choose a vibration pattern.

1. From home, tap **Apps**  > **Settings** .
2. Tap **Sounds** .

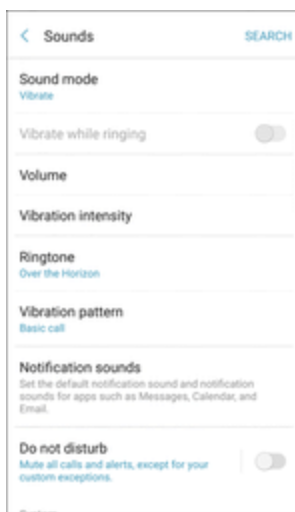

3. Tap **Vibration pattern** to select a default vibration pattern.

Notification Sounds

Set the default notification sounds for apps such as Messages, Calendar, and Email.

1. From home, tap **Apps**  > **Settings** .

2. Tap **Sounds** .

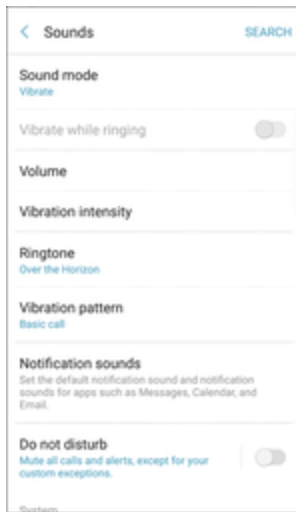

3. Tap **Notification sounds** to set options:

- **Default notification sound:** Set the default sound for notifications.
- **Messages notifications:** Set the default sound for new messages.
- **Calendar notifications:** Set the default sound for calendar events.
- **Email notifications:** Set the default sound for new email. (This option is only displayed if you have an email account set up.)

Do Not Disturb

This setting allows you to block all notifications and alerts. The options below determine what notifications can make sounds, and during what time periods you want to enter this mode.

1. From home, tap **Apps**  > **Settings** .

2. Tap **Sounds** .

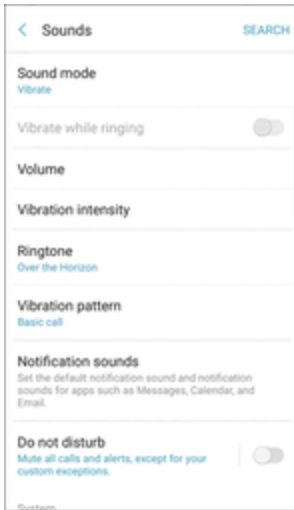



3. Tap **Do not disturb** to enable the feature.

Scheduling

This option allows you to turn Do not disturb mode on or off automatically at scheduled times.

Note: Scheduling is not available if Do not disturb mode has been turned on manually.

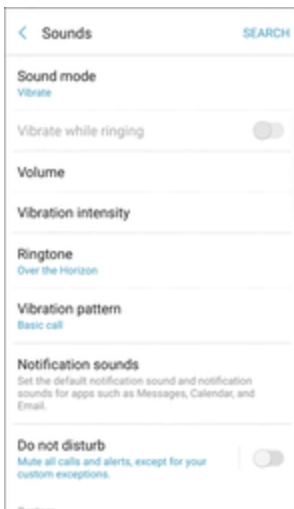

1. From home, tap **Apps**  > **Settings** .
2. Tap **Sounds** .



3. Tap **Do not disturb**.
4. Tap **Turn on as scheduled**, and set the **Days**, **Start time**, and **End time**.

Allow Exceptions

This option lets you customize which notifications are allowed while your device is in Do not disturb mode.

1. From home, tap **Apps**  > **Settings** .
2. Tap **Sounds** .

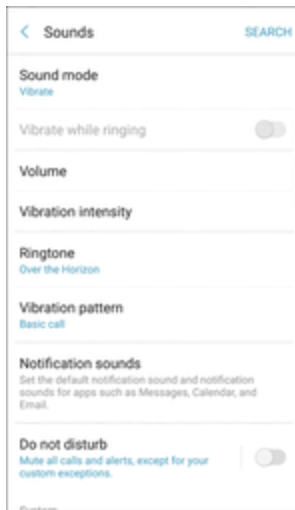

3. Tap **Sounds and vibration** > **Do not disturb**.
4. Tap **Allow exceptions**, and then tap one of the following options:
 - **No exceptions**: Allow no exceptions.
 - **Alarms only**: Allow exceptions for alarms.
 - **Custom**: Set your own exceptions.

System Sounds

Set various other system sound options.

1. From home, tap **Apps**  > **Settings** .

2. Tap **Sounds** .

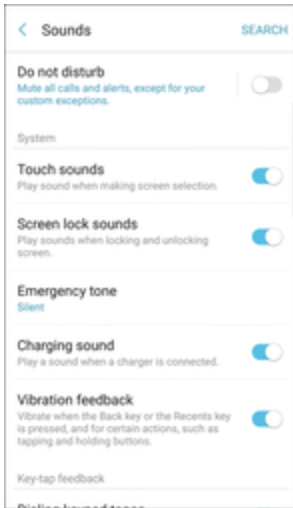

3. Tap **On/Off** to enable each option:

- **Touch sounds:** Play tones when you touch or tap the screen to make selections.
- **Screen lock sounds:** Play a sound when you unlock the screen.
- **Emergency tone:** Sound an alert, vibrate, or stay silent when an emergency alert is received.
- **Charging sound:** Play a sound when a charger is connected.
- **Vibration feedback:** Vibrate when Back or Recent are tapped, and for other actions

Key-tap Feedback

Play tones when the dialing keypad or the keyboard is tapped.

1. From home, tap **Apps**  > **Settings** .

2. Tap Sounds .

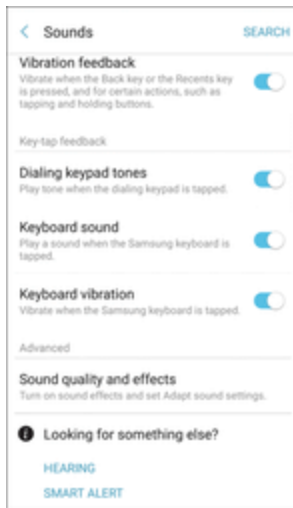

3. To **On/Off** to enable each option:

- **Dialing keypad tone:** Play a tone when the dialing keypad is tapped.
- **Keyboard sound:** Play a sound when the Samsung keyboard is tapped.
- **Keyboard vibration:** Vibrate when the Samsung keyboard is tapped.

Sound Quality and Effects

Select options for sound quality while headphones or compatible Bluetooth headsets or speakers are connected.

1. From home, tap **Apps**  > **Settings** .

2. Tap **Sounds** .

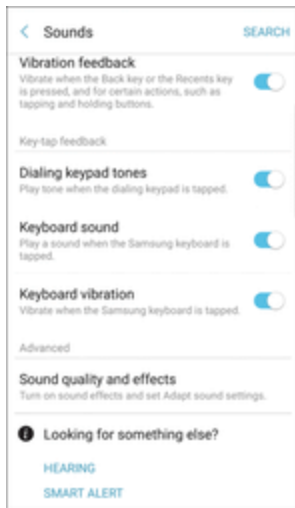

3. Tap **Sound quality and effects**.
4. Tap **Equalizer** and choose a setting, or tap **Advanced** or **Basic** to customize your sound settings.
5. Tap **On/Off** to enable each option:
 - **UHQ upscaler**: Enhance the sound resolution of music and videos for a clearer listening experience.
 - **Surround**: Recreate the effects of rich surround sound.
 - **Tube Amp Pro**: Simulate the soft timbre of a tube amplifier.
 - **Concert hall**: Simulate the reverb of a concert hall.
6. Tap **Adapt sound** and follow the prompts to customize your sound settings.

Note: Sound effects are only available while headphones or a compatible Bluetooth headset is connected.

Notifications Settings

The following topics cover your phone's Notifications settings options.

Access Notification Settings

1. From the home screen, tap **Apps**  > **Settings** .

2. Tap **Notifications** .

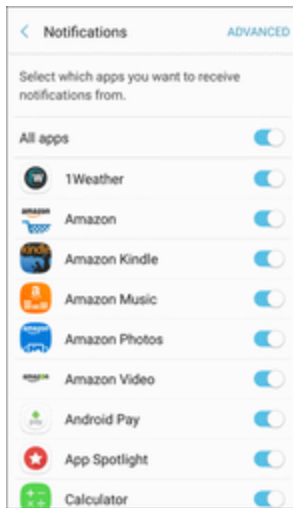

3. Tap **On/Off** next to an app to enable or disable notifications.
4. Tap **Advanced** to configure more notification options for individual apps.

Display Settings

Configure your display's brightness, screen timeout delay, and other display settings.

Display Settings Overview

The display settings menu allows you to configure the following options:

Display Setting	Description
Brightness	Set the display brightness.
Blue light filter	Use Blue light filter at night to help you sleep better. You can set a schedule to automatically turn this feature one and off.
Font	Set a default font and font size.
Edge screen	Set your Edge screen settings.
Content scaling	Enable content scaling.
Easy mode	Set your device to use Easy mode.
Icon frames	Display icons with a shaded background to make them stand out on the Home screen and Apps screen.
Screen timeout	Set a screen timeout duration. Note: Longer durations discharge the battery more quickly
Always On Display	See important information without unlocking the screen.

Display Setting	Description
Night clock	Show a clock on the Edge screen while the main screen is turned off.
Screen mode	Select a screen display mode to optimize it for the content being displayed.
LED indicator	Light up the LED indicator when charging, voice recording, or receiving notifications.
Keep screen turned off	Prevent the screen from turning on accidentally while the device is in a dark place, such as a pocket or bag.
Screen saver	Select a screen saver to be displayed when the device is charging.

Access Display Settings

1. From the home screen, tap **Apps**  > **Settings**  > **Display** .

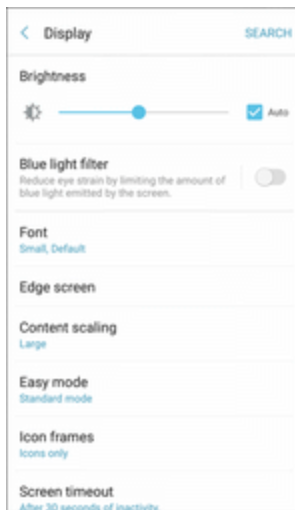

2. Set your display options.

❖ Your display settings are saved and applied.

Brightness

Adjust the screen brightness to suit your surroundings or personal preference. You may also want to adjust screen brightness to conserve battery power.

1. From home, tap **Apps**  > **Settings**  > **Display** .

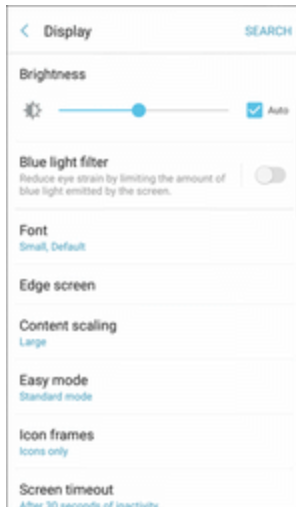

2. Customize options under Brightness:

- Drag the **Brightness** slider to set a custom brightness level.
- Tap **Auto** to allow the device to adjust brightness automatically.

Note: You can also control Brightness from the Notification panel.

Blue Light Filter

Use Blue light filter at night to help you sleep better. It adjusts your screen color to reduce the amount of blue light, helping your eyes to relax and making it easier for you to fall asleep. You can set a schedule to automatically turn this feature one and off.

1. From home, tap **Apps**  > **Settings**  > **Display** .

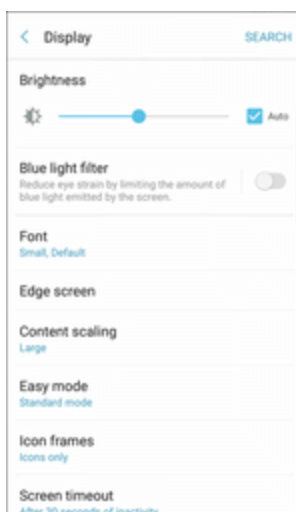

2. Tap **Blue light filter**.
3. Tap **On/Off** to enable this feature.
 - When enabled, drag the **Opacity** slider to set the opacity of the filter.
 - Set a schedule for when Blue light filter should be enabled. You can choose **No schedule**, **Sunset to sunrise**, or **Custom schedule**.

Font Size and Style

You can set the font size and style for all text that is displayed on the screen.

1. From home, tap **Apps**  > **Settings**  > **Display** .

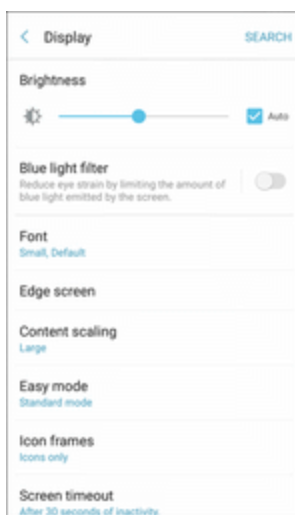

2. Tap **Font** to choose a font size and style.
 - Drag the slider to adjust the font size.
 - Tap a font style to select a font, or tap **Download fonts** to find new fonts from Galaxy Apps.
3. Tap **Done** to set the font size and style.

Edge Screen Settings

Manage the panels that display on the Edge screen, including your own custom panels, and set up night mode.

For more details on using the Edge screen, see [Edge Screen](#).

To access Edge screen settings:

1. From home, tap **Apps**  > **Settings**  > **Display** .
2. Tap **Edge screen**.

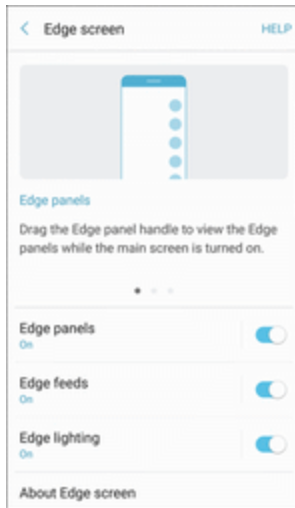

– or –

Swipe the Edge screen toward the center, and then tap **Settings** .

The following options are available:



- **Edge panels:** Configure Edge for accessing apps, tasks, and contacts, as well as view news, sports, and other information on the Edge screen.
- **Edge feeds:** Configure Edge feeds, which display select information and notifications on the Edge screen when the screen is turned off.
- **Edge lighting:** Set the Edge screen to light up when you receive calls or notifications while the phone is turned over. If People edge is also turned on, the color of the indicator depends on your My people settings.
 - **Quick reply:** Tap **On/Off** to enable this feature, which lets you reject an incoming call and send a preset message to the caller by placing your finger on the heart rate sensor and holding it in place for 2 seconds while the device is turned over.
- **About Edge screen:** View the Edge screen version number, check for updates, and view open source licenses.

Edge Panels Settings

Customize your Edge panels:

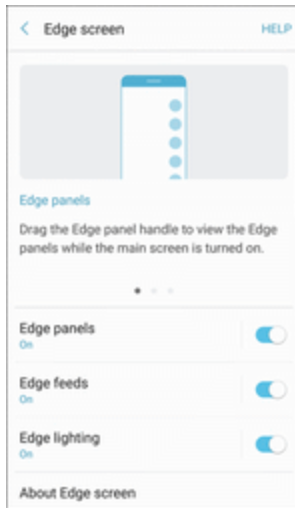
1. From home, tap **Apps**  > **Settings**  > **Display** .
2. Tap **Edge screen**.



3. Tap **Edge panels**.
4. Tap **On/Off** to enable the feature. The following options are available:
 - **Checkbox** : Enable or disable each panel.
 - **Download**: Search for and download more Edge panels from Galaxy Apps.
 - **Reorder**: Change the order of the panels by dragging them to the left or right.
 - **Edit** (if available): Configure individual panels by tapping.
 - **More options** > **Handle settings**: Drag **Position**  to change the position of the Edge panel handle along the edge of the screen, and then configure the following Edge panel handle settings:
 - **Position**: Choose either **Right side** or **Left side** to set which side the Edge screen appears on.
 - **Size**: Choose the size of the Edge screen handle. It can be **Small**, **Medium**, or **Large**.
 - **Transparency**: Drag the slider to adjust the transparency of the Edge screen handle.
5. Tap **Back**  to save changes.



Edge Feeds Settings

Edge feeds display select information and notifications on the Edge screen when the screen is turned off.

To configure the Edge feeds:

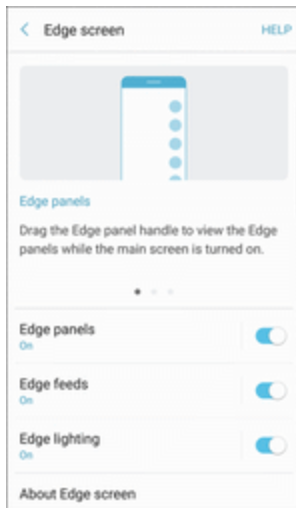
1. From home, tap **Apps**  > **Settings**  > **Display** .
2. Tap **Edge screen**.



3. Tap **Edge feeds**.
4. Tap **On/Off** to activate the Edge feeds feature.
 - **Checkbox** : Enable or disable each feed.
 - **Download**: Search for and download more Edge feeds from Galaxy Apps.
 - **Edit** (if available): Configure a feed.
 - **More options** > **Reorder**: Change the order of the feeds by dragging them to the left or right.
 - **More options** > **Edge feed timeout**: Configure how long the Edge screen stays on when activated.
5. Tap **Back**  to save changes.

Edge Lighting Settings

Edge lighting and Quick reply are features that activate when your device is turned over (display side down).

Edge lighting illuminates the Edge screen when a notification is received. If People edge is also on, the color of the indicator is the one assigned to the contact who is calling or messaging.

To turn on Edge lighting:

1. From home, tap **Apps**  > **Settings**  > **Display** .
2. Tap **Edge screen**.

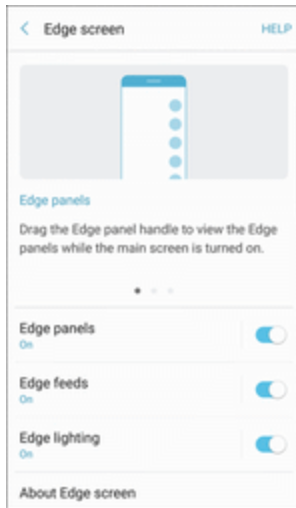

3. Tap **Edge lighting**.
4. Tap **On/Off** to turn on the feature.
5. Tap **Back**  to save changes.

Quick Reply Settings

Quick reply allows you to reject an incoming phone call with a text message by placing your finger on the heart rate sensor for two seconds. The call is rejected, and a preset message is sent to the caller.

To turn on and configure Quick reply:

1. From home, tap **Apps**  > **Settings**  > **Display** .

2. Tap **Edge screen**.

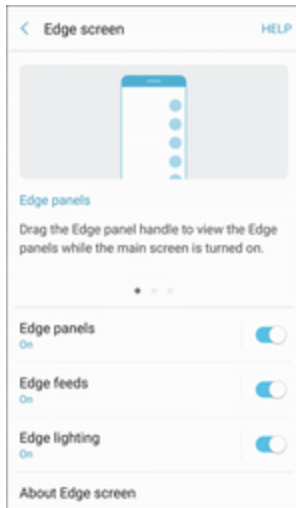

3. Tap **Edge lighting** > **Quick reply**.
4. Tap **On/Off** to enable Quick reply.
5. Tap the message to edit the text reply.
6. Tap **Back**  to save changes.

About Edge Screen

You can view the current software version and license information for the Edge screen feature.

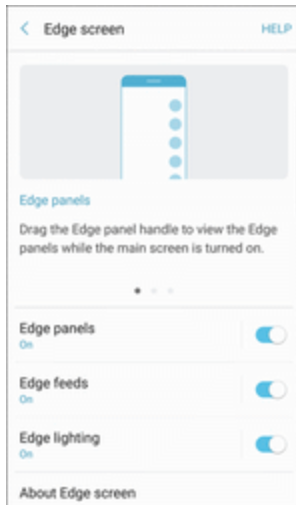

1. From home, tap **Apps**  > **Settings**  > **Display** .
2. Tap **Edge screen**.



3. Tap **About Edge screen**.

Content Scaling

You can scale content to appear larger or smaller on the screen.

1. From home, tap **Apps**  > **Settings**  > **Display** .
2. Tap **Content scaling**.

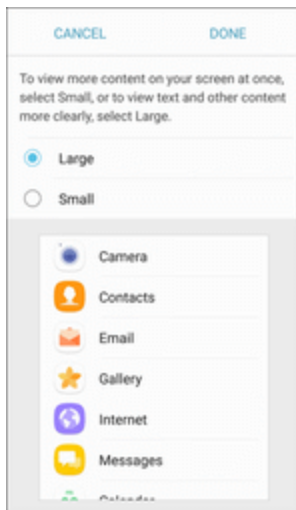

3. Choose either **Large** or **Small**.
4. Tap **Done** to set object scale.

Easy Mode

Easy mode provides a simpler experience using your phone, with a simpler home screen layout and simpler app interactions. If you are a first-time smartphone user, or just to want to simplify the operation of your phone, you can turn on Easy mode at any time.

1. From home, tap **Apps**  > **Settings**  > **Display** .
2. Tap **Easy mode**.

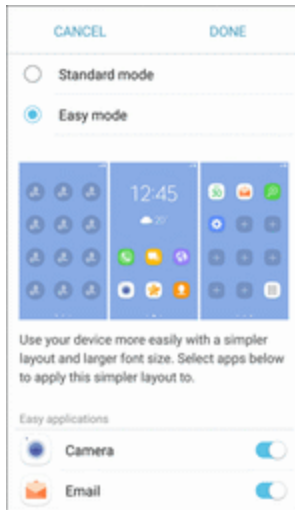

3. Select the apps you want to use from the Easy applications list.
4. Tap **Done** to apply your Easy mode settings.

Return to Standard Mode

You can use the Easy mode Settings menu to return to Standard mode.

1. From home, tap **Apps**  > **Settings**  > **Display** .

2. Tap **Easy mode**.

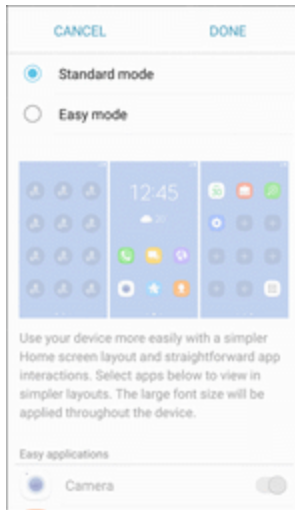

3. Tap **Standard mode**, and then tap **Done**.

Icon Frames

You can show icons with a shaded background to make them stand out on the Home screen and Apps list screen.

1. From home, tap **Apps**  > **Settings**  > **Display** .
2. Tap **Icon frames**.

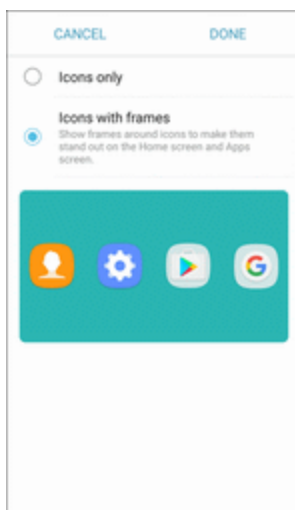

3. Choose one of the following options:
 - **Icons only:** Show icons only.
 - **Icons with frames:** Show icons with shaded backgrounds.

4. Tap **Done**, and confirm when prompted.

Screen Timeout

Turn the screen off after a set amount of time.

1. From home, tap **Apps**  > **Settings**  > **Display** .
2. Tap **Screen timeout**.

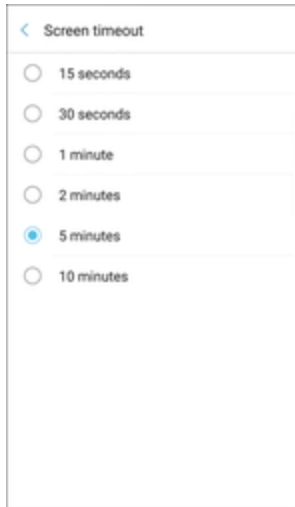

3. Choose a time period.

Always On Display

See important information without unlocking the screen. You can select an image or information to show on the standby screen. Double-tap a notification icon to view that notification.

Note: If you double-tap a notification and a screen lock is enabled, you are prompted to unlock your device.

1. From home, tap **Apps**  > **Settings**  > **Display** .

2. Tap **Always On Display**.



3. Tap **On/Off** to enable the feature, and then set the following options:

- **Layouts:** Choose a layout for the standby screen. The following options are available:
 - **Content to show:** Choose to show Clock, Calendar, or Image.
 - **Show notifications:** Enable or disable showing notification icons on the standby screen.
 - **Format:** Choose a format for the content selected. You can change the color and background image by selecting a format.
- **Set schedule:** Choose when to start and end Always On Display.
- **About Always On Display:** View the current software version and license information.

Night Clock

Set up a clock that displays on the Edge screen when the screen is off. Night mode is available for a maximum of 12 hours.

1. From home, tap **Apps**  > **Settings**  > **Display** .

2. Tap **Night clock**.



3. Tap **On/Off** to enable the Night clock feature.

- Tap **Start** to set the time for the Night clock to activate.
- Tap **End** to set the time for the Night clock to deactivate.
- Tap **Night clock position** to position the Night clock on the Right side or the Left side.

Screen Mode

Choose a screen mode to match your type of viewing.

1. From home, tap **Apps**  > **Settings**  > **Display** .
2. Tap **Screen mode**.





3. Tap **Adaptive display** if you want your device to automatically optimize the display to match the type of image displayed and other criteria, such as battery level.

– or –

Choose a specific type of screen mode based on what you are viewing.

LED Indicator

Light up the LED indicator when charging, voice recording, or receiving notifications.

1. From home, tap **Apps**  > **Settings**  > **Display** .
2. Tap **LED indicator** to turn the feature on or off.

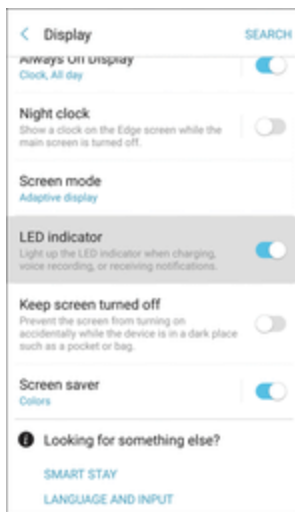

Keep Screen Turned Off

Prevent the screen from turning on accidentally while the device is in a dark place, such as a pocket or bag.

1. From home, tap **Apps**  > **Settings**  > **Display** .

2. Tap **Keep screen turned off** to enable this feature.

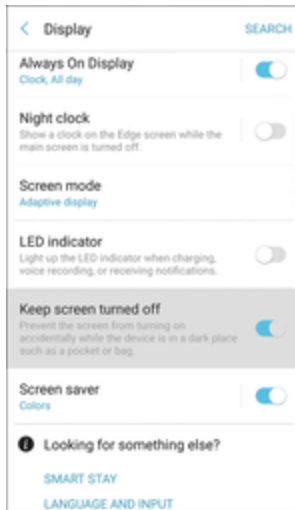



Screen Saver

Screen saver controls what is displayed on the screen when the device is charging. You can choose to display colors or photos.

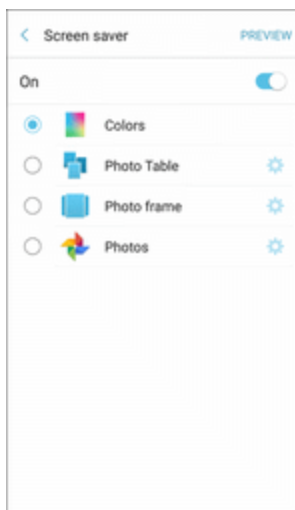
1. From home, tap **Apps**  > **Settings**  > **Display** .
2. Tap **Screen saver**.



3. Tap **On/Off** to enable Screen saver.
4. Configure options:



- **Colors:** Tap the selector to display a changing screen of colors.
- **Photo Table:** Display pictures in a photo table. Tap  **Settings** for options.
- **Photo frame:** Display pictures in a photo frame. Tap  **Settings** for options.
- **Photos:** Display pictures from your Google Photos™ account. Tap  **Settings** for options.
- **Preview:** See a demonstration of Screen saver.

Advanced Features Settings

Configure features on your device that make it easier to use.

S Pen Settings

Configure options and settings for the S Pen.

1. From home, tap **Apps**  > **Settings**  > **Advanced features** .
2. Tap **S Pen**.

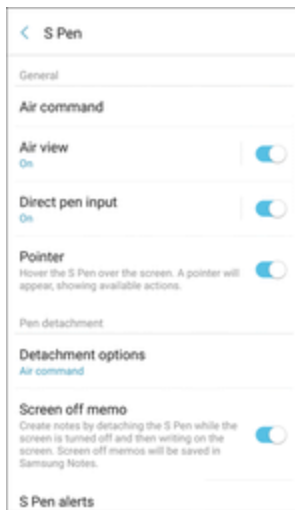

3. Configure any of the following settings:
 - **Air command:** Turn the Air command feature on.
 - **Air view:** Turn the Air view feature on.
 - **Direct pen input:** Turn the Direct pen input feature on. This feature allows you to switch from the keyboard to the S Pen when filling in form fields.

- **Pointer:** Turn the pointer on. The pointer appears on the screen when the tip of the S Pen is hovering close enough. Holding the pointer over some features can reveal what an item is or what it does.
- **Detachment options:** Display the Air command menu, create a note, or do nothing when the S Pen is detached.
- **Screen off memo:** Create a note by detaching the S Pen while the screen is off and writing on the screen.
- **S Pen alerts:** Tap the check box to set your device to sound an alert and show a pop-up if you forget to attach the S Pen and walk away from it with your device.
- **S Pen power saver:** Turning off pen detection when the pen is attached can extend battery life.
- **S Pen sound:** Tap the check box to enable sounds when writing with the S Pen.
- **S Pen vibration:** Activate vibration feedback when writing with the S Pen.

Smart Stay

Smart stay detects your face with the front camera so that the screen stays on while you are looking at it.

1. From home, tap **Apps**  > **Settings**  > **Advanced features** .

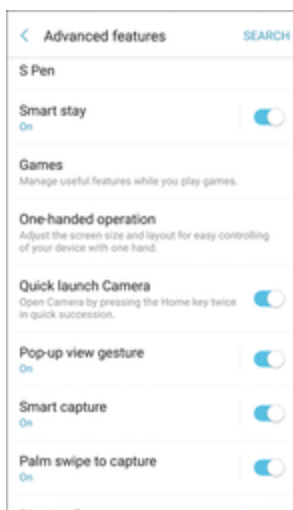



2. Tap **Smart stay**, and then tap **On/Off** to turn the feature on.

Manage Game Features

Configure features on your device that make it easier to use. For example, you can control certain device actions by picking up the phone and by touching the screen with the palm of your hand or

turning over the device.

1. From home, tap **Apps**  > **Settings**  > **Advanced features** .
2. Tap **Games**.



3. Tap **On/Off** to enable or disable the following:
 - **Game Launcher:** Automatically arranges all your games in one place.
 - **Game Tools:** When enabled, a button floating over top of your game provides convenient game features, such as No alerts during game, Minimize and alive, Screenshot, and Record. Game tools can also access your Contacts, Storage, Microphone, and Camera.

One-Handed Operation

Adjust the screen size and layout for easy control of your device with one hand.

1. From home, tap **Apps**  > **Settings**  > **Advanced features** .

2. Tap **One-handed operation**.

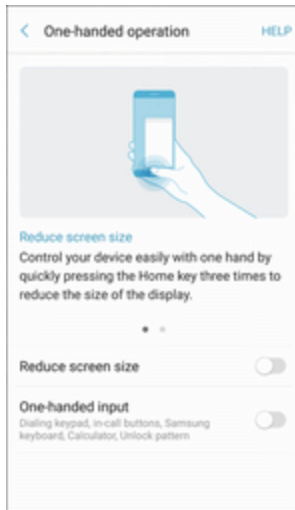

3. Tap **On/Off** to enable or disable the following:

- **Reduce screen size:** Press the Home key three times in quick succession to reduce the size of the display.
- **One-handed input:** Adjust the size and position of the keyboard and other input methods for easier input with one hand.

Other Advanced Features

Configure other useful features. For example, you can control certain device actions by picking up the device and by touching the screen with the palm of your hand or turning over the device.

1. From home, tap **Apps**  > **Settings**  > **Advanced features** .

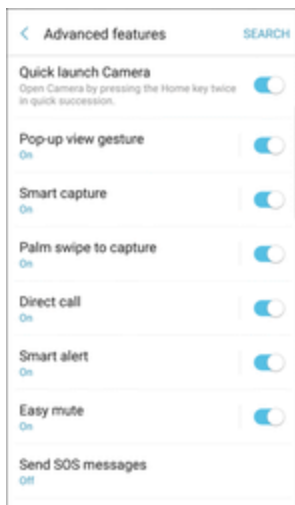

2. Tap **On/Off** to enable or disable each of the following.

- **Quick launch Camera:** Open the Camera by quickly pressing the Home key twice.
- **Pop-up view gesture:** View an app in pop-up view by swiping downwards diagonally from either corner at the top of the screen while the app is open and shown on the screen.
- **Smart capture:** Capture an image of any scrollable areas of the screen that are currently hidden, as well as the area that is visible, and crop and share the screenshot immediately.
- **Palm swipe to capture:** Capture an image of the screen by swiping the edge of your hand across it, from side to side, keeping in contact with the screen.
- **Direct call:** Call the contact whose call log, message, or contact details are currently on the screen by bringing the device close to your ear.
- **Smart alert:** Set the device to vibrate when you pick it up to notify you about missed calls and messages.
- **Easy mute:** Mute sounds and video by covering the screen or turning over the device.
- **Send SOS messages:** Send a quick alert to your primary contacts when you are in an emergency situation by pressing the Power key quickly three times.
 - **Send messages to:** Add recipients by creating new contacts or selecting from Contacts.
 - **Attach pictures:** Send pictures to your emergency contacts.
 - **Attach audio recording:** Send a short audio message to your emergency contacts.
- **Direct share:** Share content with specific people directly using the sharing panel from within any app.
- **Video enhancer:** Enhance the image quality of your videos.

Applications Settings

View information and configure settings for all apps on your phone.

Access Applications Settings

1. From home, tap **Apps**  > **Settings**  > **Applications** .

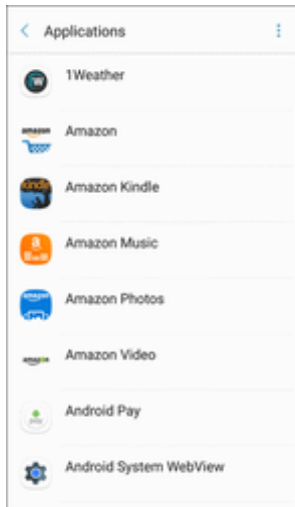

2. Tap on an app to view and configure its settings.
 - Depending on the app and its location, you may be able to force the app closed, uninstall or disable the app, clear cache and data, and more.

Applications Overview

You can download and install new applications on your device. Use Application settings to manage your downloaded and preloaded applications.



Warning: Because this device can be configured with system software not provided by or supported by Google or any other company, you operate this software at your own risk.

Application Options

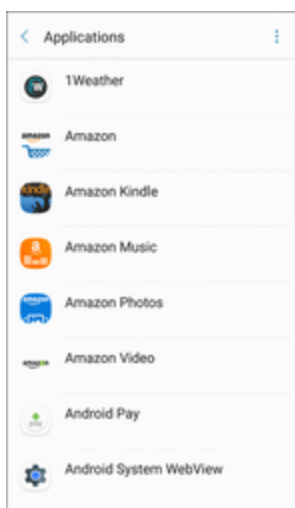
1. From home, tap **Apps**  > **Settings**  > **Applications** .



2. If you have disabled applications:

- Tap **All apps**  at the top left of the screen.
 - Tap **All apps**, **Enabled**, or **Disabled**.
3. Tap **More options**  to configure the following:
- **Default applications:** Choose or change apps that are used by default for certain features, like email or browsing the Internet.
 - **App permissions:** Grant permission for access to your device's information to individual apps.
 - **Show/Hide system apps:** Show or hide system (background) apps.
 - **Apps that can appear on top:** Choose apps that can run on top of other running apps.
 - **Change system settings:** Select which apps can change system endings.
 - **Reset app preferences:** Reset options that have been changed. Existing app data is not deleted.

Note: Options vary by application.

Manage Apps

You can view and update information about an application, including memory usage, default settings, and permissions.

1. From home, tap **Apps**  > **Settings**  > **Applications** .

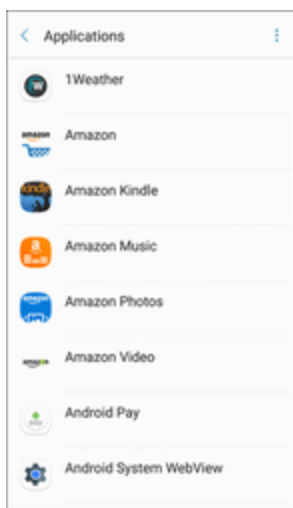





2. Tap an application to view and update information about the application. The following options are displayed:

- **Uninstall/Disable:** Uninstall or disable the application. Preloaded apps can only be disabled.
- **Force stop:** Stop an app that is misbehaving. Restart your device if stopping an app, process, or service causes your device to stop working correctly.
- **Mobile data:** View mobile data usage.
- **Battery:** View battery usage since the last full charge.
- **Storage:** Manage the app's storage usage.
- **Memory:** View memory usage.
- **Notifications:** Configure notifications from the app.
- **Permissions:** View permissions granted to the app for access to your device's information.
- **Set as default:** Set the app as a default for a certain category of apps.

Default Applications

Set or clear default applications for certain built-in features of the phone.

1. From home, tap **Apps**  > **Settings**  > **Applications** .
2. Tap  **More options** > **Default applications**.

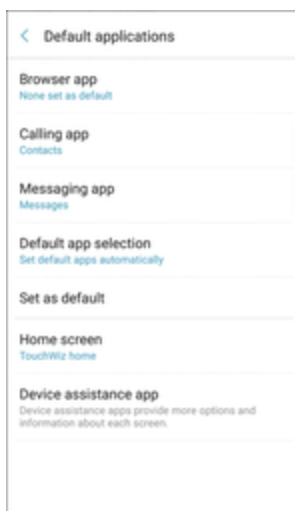





3. Tap each default setting to see what services or applications are available to set as the default.
 - **Browser app:** Choose a default browser app.
 - **Calling app:** Choose a default calling app.
 - **Messaging app:** Choose a default messaging (text and multimedia) app.

- **Default app selection:** Choose default apps for other functions.
- **Set as default:** Select a different app to open related files.
- **Home screen:** Choose a Home screen type.
- **Device assistance app:** Choose an app that provides assistance for using your device.

Note: If you choose a default messaging app other than Messages (Google Hangouts™ for example), you will not be able to use the Messages app unless you restore it as the default messaging app.

App Permission Settings

Configure settings and permissions for your phone's apps.

1. From home, tap **Apps**  > **Settings**  > **Applications** .
2. Tap  > **App permissions**.
3. Tap an app to configure its settings and permissions.

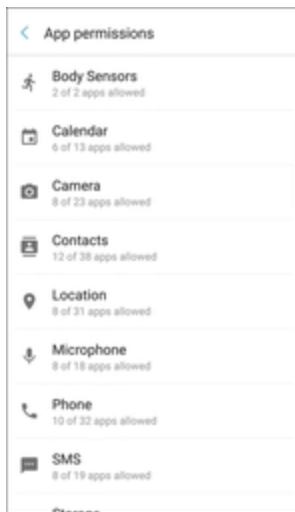

Note: Available settings and permissions vary by app.

Personal Settings

The following topics cover your phone's personalization settings, including wallpaper, themes, lock screen and security settings, accounts, and more.

Wallpapers and Themes Settings

The following topics cover your phone's Wallpapers and themes settings options.

Wallpaper Settings

You can change the wallpaper for the Home and lock screens.

- From home, tap **Apps**  > **Settings**  > **Wallpapers and themes**  > **Wallpapers**.

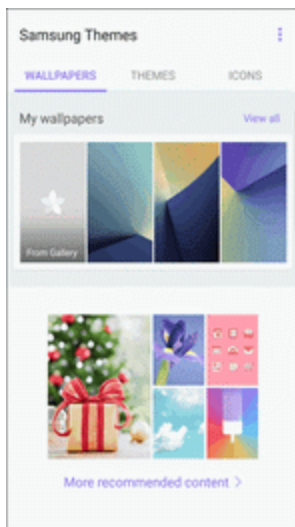

For more information, see [Change the Wallpaper](#).

Themes

Themes are packages of visual content that provide different wallpapers and icons for your phone.

Change the Theme

1. From home, tap **Apps**  > **Settings**  > **Wallpapers and themes**  > **Themes**.

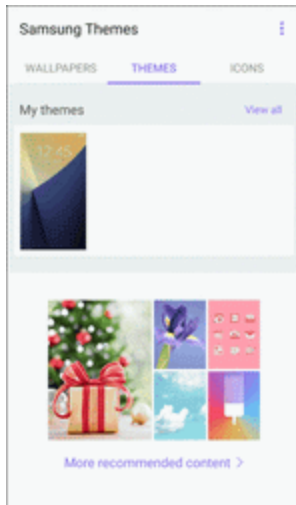

2. Tap a theme to preview it.
 - Tap **View all** to see all available themes.
3. To apply a theme, tap the theme, and then tap **Apply**.
 - ❖ Your theme is changed.

Icons

Apply custom icons to replace built-in app icons.

Change the Icons

1. From home, tap **Apps**  > **Settings**  > **Wallpapers and themes**  > **Icons**.

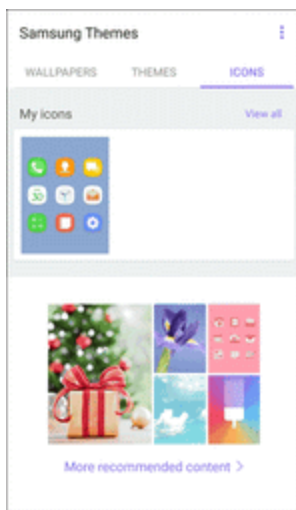

2. Tap an icon set to view a preview of the icons.

❖ Tap **View all** to see all available icon sets.

3. Tap **Apply** to apply the selected icon set.

Lock Screen and Security Settings

The lock screen settings let you set your method for unlocking your phone, customize lock screen options, determine whether to show tips for unlocking the phone, and enter your owner information to be displayed on the lock screen.

The Security settings let you set encryption options, password visibility, administrator settings, and credential storage options.

The Lock screen and security settings menu allows you to configure the following options:

Category	Description
Screen lock type	Increase the security of your phone by creating a screen lock.
Info and app shortcuts	Show the dual clock, owner's information, or app shortcuts on the lock screen.
Notifications on lock screen	Enable notifications to be displayed on the lock screen.
Secure lock settings	Set your secure lock functions.
Fingerprints	Secure your phone using fingerprint recognition.
Irises	Secure your phone using iris recognition.
Unknown sources	Allow or deny installation of apps from sources other than the Google Play store app.
Secure Folder	Lock your private content and apps to enhance security.
Secure startup	Protect your device by using a screen lock when your device turns on.
Encrypt SD card	Protect your SD card (not included) by encrypting its data.
Other security settings	Configure settings for encryption, password visibility, security updates, credentials, and other security features.

Access Lock Screen and Security Options

- From home, tap **Apps**  > **Settings**  > **Lock screen and security** .

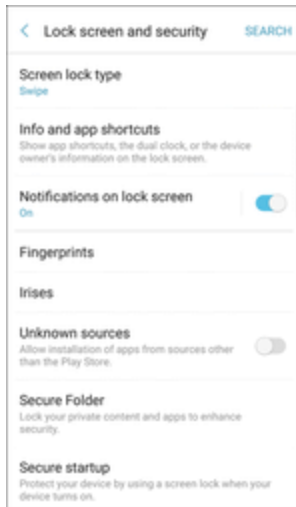

- ❖ The lock screen and security menu opens.

Screen Lock

You can increase the security of your phone by creating a screen lock. When enabled, you have to draw the correct unlock pattern on the screen, enter the correct PIN, enter the correct password, or scan your fingerprint or irises to unlock the phone's control keys, buttons, and touchscreen.

In order from least secure to most secure, the available screen lock options are:

- Swipe
- Pattern
- PIN
- Password
- Fingerprints
- Irises

Important: To protect your phone and data from unauthorized access, it is recommended that you use the highest security level available (Password, Fingerprint, or Iris protection). It is also recommended you frequently change your password to ensure the safety of your phone and personal data.

Access Screen Lock Settings

1. From home, tap  **Apps > Lock screen and security** .

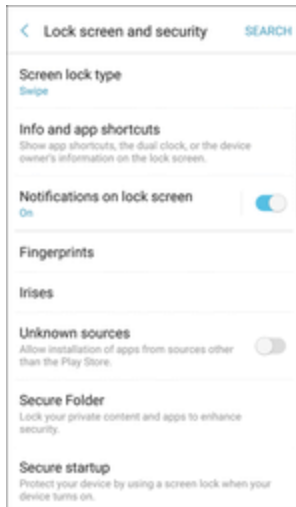

❖ The lock screen and security menu opens.

2. Tap **Screen lock type** and follow the prompts to enter your pattern, password, fingerprint, or iris scan.

❖ The Screen lock settings menu opens.

Use Swipe to Unlock the Screen

- From the Screen lock type menu, tap **Swipe** to save the setting.

❖ The screen lock is set.

Use a Screen Unlock Pattern

1. From the Screen lock type menu, tap **Pattern**.
2. Draw the screen unlock pattern by connecting at least four dots in a vertical, horizontal, or diagonal direction. Lift your finger from the screen when finished.

❖ The phone records the pattern.



3. Tap **Continue**.
4. When prompted, draw the screen unlock pattern again, and then tap **Confirm**.



❖ The screen unlock pattern is saved.

5. Enter a backup PIN, tap **Continue**, re-enter the PIN, and tap **OK** to save your screen unlock pattern.

❖ The screen lock is set.

- If you fail to draw the correct unlock pattern on the screen after five attempts, you will be prompted to wait for 30 seconds before you can try again.

Note: If you do not want the unlock pattern to display on the screen when you unlock it, from home, tap **Apps**  > **Settings**  > **Lock Screen and Security** > **Secure lock settings**, and then tap **On/Off** next to **Make pattern visible** to turn it off.

Note: To change your unlock screen pattern, from home, tap **Apps**  > **Settings**  > **Lock Screen and Security** > **Screen lock type**.

Use a Screen Unlock PIN

1. From the Screen lock type menu, tap **PIN**.
2. Enter a PIN, tap **Continue**, re-enter your PIN, and tap **OK** to save the setting.

 The screen lock is set

- If you fail to enter the correct PIN after five attempts, you will be prompted to wait for 30 seconds before you can try again.

Use a Screen Unlock Password

1. From the Screen lock type menu, tap **Password**.
2. Enter a password with at least 4 characters, including at least one letter, tap **Continue**, and then enter your password again to confirm it.

 The screen lock is set.

- If you fail to enter the correct password after five attempts, you will be prompted to wait for 30 seconds before you can try again.

Use a Fingerprint Screen Lock

With a Fingerprint screen lock, place your finger on the Home key.

Note: Before using the Fingerprint screen lock option, you will need to register your fingerprint on your phone.

1. From the Screen lock type menu, tap **Fingerprints**.
2. Follow the prompts to set up your fingerprints.

Note: Fingerprint recognition uses the unique characteristics of each fingerprint to enhance the security of your device. The likelihood of the fingerprint sensor confusing even small areas of two different fingerprints is very low. But in rare cases, the sensor may recognize a fingerprint that is similar to a registered fingerprint.

Iris Lock Settings

Use iris recognition as an alternative to entering passwords in certain apps. You can also use your irises to verify your identity when logging in to your Samsung account.

Warning! Some people may have dizziness, seizures, epileptic seizures or blackouts triggered by light flashes or patterns, even if they have never had a seizure or blackout before. Anyone who has had a seizure, loss of awareness, or other symptom linked to an epileptic condition, or has a family history of such symptoms or conditions, should see a doctor before using the Iris Scanner.

DO NOT stare directly into the infrared iris recognition LED as prolonged use can cause eye strain. Do not stare at the iris recognition LED light when your eyes are less than 20 cm (~8 inches) away from the device, for best results keep your eyes between 25-35cm (~10-14 inches) away for optimum recognition.

Note: The Iris Scanner is not intended to be used as a medical device and the biometric data collected and stored locally by the mechanism is not intended to be used for any diagnostic, therapeutic, or preventative purposes. Please follow all instructions for use of this feature.

For best results, remove eye glasses and sun glasses. Do not use the Iris Scanner in bright sunlight or areas with excessive reflected light (for example, by the pool or seashore). Do not use the Iris Scanner in low light. Look straight at the device (not up, down or sideways), and hold your head still for the scan. Tinted contact lenses and surgically repaired or replaced iris lenses may interfere with operation of the Iris Scanner. Do not walk or operate a vehicle while using the Iris Scanner.

Please follow all instructions for use of this feature. For more information, refer to the online support content or visit samsung.com/us/irisscanner.

Register Irises

To use your irises to unlock your device, you must set a pattern, PIN, or password. For best results, perform the setup process indoors, and remove your glasses or contact lenses.

1. From the Screen lock type menu, tap **Irises**.
2. Follow the prompts to register your irises.

Note: To register just one of your irises, tap Register one iris on the setup screen.

Iris Verification



Iris verification can be used for other accounts accessed from your device.

- From the Lock screen and security menu, tap **Irises** for the following options:
 - **Remove:** Delete existing irises.
 - **My irises:** Manage your existing irises.
 - **Mask on preview screen:** Choose a mask to display when using the iris scanner.

- **Web sign-in:** Enable to use your irises to sign in to websites.
- **Verify Samsung account:** Enable to use your irises to verify your Samsung account when you access a feature or app that requires it.
- **Iris unlock:** Enable to unlock the device using your irises.



Disable the Screen Lock

Follow the instructions below to turn off your current screen lock.

1. From home, tap **Apps**  > **Settings**  > **Lock screen and security** .
 - ❖ The lock screen and security menu opens.
2. Tap **Screen lock type**.
 - ❖ The Screen lock settings menu opens.
3. Draw your unlock screen pattern, enter your PIN or password, or scan your fingerprint or irises.
4. Tap **None**.
 - ❖ The screen lock is disabled.

Unknown Sources



Enable installation of non-Google Play applications.

1. From home, tap **Apps**  > **Settings**  > **Lock screen and security** .
2. Tap **Unknown sources** to enable this option.

Warning: Enabling installation of third-party applications can cause your device and personal data to be more vulnerable to attacks by unknown sources.

Secure Folder



Lock your private content and apps to enhance security. You must sign in to your Samsung account in order to use Secure Folder. You must also set a secure lock for your device.

1. From home, tap **Apps**  > **Settings**  > **Lock screen and security** .
2. Tap **Secure folder** and follow the prompts to secure content on your device.

Secure Startup



Protect your device by using a screen lock when your device turns on.

Require a numeric PIN or password to decrypt your device each time you power it on.

1. From home, tap **Apps**  > **Settings**  > **Lock screen and security** .
2. Tap **Secure startup** and follow the prompts to encrypt all data on your device.

Encrypt SD Card

Require a numeric PIN or password to decrypt your optional memory card (not included) when you first access it after powering on your device.



1. From home, tap **Apps**  > **Settings**  > **Lock screen and security** .
2. Tap **Encrypt SD card**. A description of the encryption process is displayed.
3. Tap **Encrypt SD card** again and follow the prompts to encrypt all data on your memory card.

Other Security Settings

Change other security settings, such as those for security updates and credential storage.



View Passwords

Display password characters briefly as you type them.

1. From home, tap **Apps**  > **Settings**  > **Lock screen and security** .
2. Tap **Other security settings** > **Make passwords visible** to turn the feature on.



Security Update Service

Automatically receive security updates.

1. From home, tap **Apps**  > **Settings**  > **Lock screen and security** .
2. Tap **Other security settings** for the following Security update service options:
 - **Security policy updates**: Automatically or manually check for security policy updates.
 - Automatic updates can also be limited to only when your device is connected to a Wi-Fi network.
 - **Send security reports**: Use Wi-Fi to send security reports to Samsung for threat analysis.



Device Administration

Manage your device administrators and application installation privileges.

1. From home, tap **Apps**  > **Settings**  > **Lock screen and security** .
2. Tap **Other security settings** > **Device administrators**.
 - Tap **Android Device Manager** to allow it to lock or erase a lost device.



Credential Storage

Manage your security certificates. If a certificate authority (CA) certificate gets compromised or for some other reason you do not trust it, you can disable or remove it.

1. From home, tap **Apps**  > **Settings**  > **Lock screen and security** .
2. Tap **Other security settings** for the following Credential storage options:
 - **Storage type:** Select a storage location for credential contents.
 - **View security certificates:** Display certificates in your device's ROM and other certificates you have installed.
 - **User certificates:** View user certificates.
 - **Install from device storage:** Install a new certificate from storage.
 - **Clear credentials:** Erase the credential contents from the device and reset the password.

Advanced Security Settings

Use these options to configure advanced security settings.

1. From home, tap **Apps**  > **Settings**  > **Lock screen and security** .
2. Tap **Other security settings** for the following advanced options:
 - **Trust agents:** Perform selected actions when trusted devices are connected.
 - To view Trust agents, set up a secured screen lock (Password, PIN, Pattern, Fingerprints, or Irises). For more information, see [Screen Lock](#).
 - **Pin windows:** Pin an app on your device screen, preventing access to other features of your device.
 - **Usage data access:** View the applications that can access your device's usage history.
 - **Notification access:** View the applications that can access notifications you receive on your device.
 - **Do not disturb permission:** View which apps have permission to change the Do not disturb settings.

Cloud and Accounts Settings

Set up and manage accounts, including your Google Account, Samsung account, email, and social networking accounts. Depending on the account, you can choose to synchronize your calendar, contacts, and other types of content.

Access Cloud and Accounts Settings

- From the home screen, tap **Apps**  > **Settings**  > **Cloud and accounts** .

The table below outlines your **Cloud and accounts** settings.

Category	Description
Samsung Cloud	Keep your data safe by backing up and restoring your device. You can also sync your data from multiple devices.
Accounts	Add and manage all your email, social networking, and picture and video sharing accounts.
Backup and Reset	Back up your phone's data and settings to Google servers before resetting your phone to the original factory settings.
Smart Switch	Transfer content from your old device to this device.

Samsung Cloud

Keep your data safe by backing up and restoring your device. You can also sync your data from multiple devices.

- From the home screen, tap **Apps**  > **Settings**  > **Cloud and accounts** .
- Tap **Samsung cloud**.

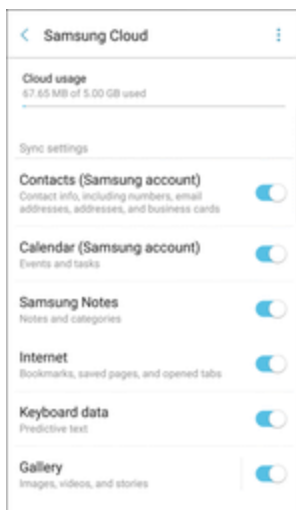

- If a Samsung account has not been added, tap **Add account** and follow the prompts.
- From the Samsung cloud menu, the following options are available:
 - Cloud usage:** View how much cloud storage your data is using.
 - Sync settings:** Tap the following items to enable or disable syncing:

- **Calendar (Samsung account):** Sync your events and tasks.
- **Contacts (Samsung account):** Sync contact info.
- **Samsung Notes:** Sync your notes and categories.
- **Internet:** Sync bookmarks, saved pages, and opened tabs from your browser.
- **Keyboard data:** Sync predictive text data.
- **Gallery:** Sync your images and videos.
- **Back up my data:** Choose which content from your device to back up to the cloud. Tap **Auto back up** to automatically back up your data every 24 hours.
- **Restore:** Choose the device that you have recently backed up and the backup package that you want to restore.
- **More options** :
 - **Sync now:** Sync all selected settings.
 - **Network settings:** Limit syncing data to when the device is connected to a Wi-Fi network.
 - **Remove account:** Remove your Samsung account.

Accounts

Add and manage all your email, social networking, and picture and video sharing accounts.

Set Up a New Account

1. From the home screen, tap **Apps**  > **Settings**  > **Cloud and accounts** .

2. Tap **Add account**.

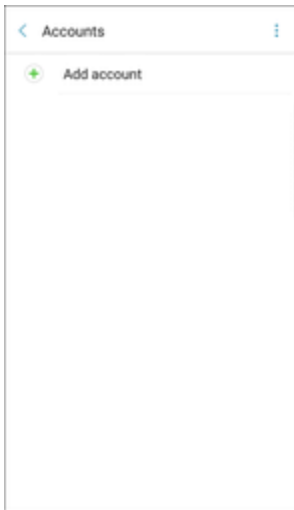

❖ An Add account window appears.

3. Tap an account type and then follow the prompts to add the required account information.

❖ The account is added to the accounts list.

Manage Existing Accounts

1. From home, tap **Apps**  > **Settings**  > **Cloud and accounts**  > **Accounts**.

2. Tap the account type to see the existing accounts.

❖ The account settings menu appears.

3. View and configure your account settings as desired.

❖ The account options are updated.

Backup and Reset

Your phone's **Backup and reset** menu lets you back up your phone's data and settings to Google servers before resetting your phone to the original factory settings. The Factory data reset erases all data from the phone's application storage, including:

- Your Samsung account
- Your Google Account
- All other email and social networking accounts
- System and application data and settings
- Downloaded applications

Backup and Reset Overview

The following options are available in the Backup and reset menu:

Backup and Reset Option	Description
Back up my data	Enable backup for application data, Wi-Fi passwords, and other settings to your Samsung account.
Restore	When reinstalling an application, backed up settings and data will be restored from your Samsung account.
Back up my data	Enable backup for application data, Wi-Fi passwords, and other settings to your Google Account.
Backup account	Select the Google Account used to back up data.
Automatic restore	When reinstalling an application, backed up settings and data will be restored from your Google Account.
Auto restart	Optimize your device by restarting it automatically at set times. The device only restarts if it is not in use and battery power is more than 30%.
Reset settings	Reset your device to its factory default settings, resetting everything except the security, language, and account settings. Personal data is not affected.
Reset network settings	Reset Wi-Fi, Mobile data, and Bluetooth settings with Reset network settings.
Factory data reset	Reset all settings and delete all data on phone.

- Performing a factory data reset erases all data on the phone. It is recommended that you back up important data before performing a factory data reset.
- Erased information cannot be restored. Only erase data after you are sure you have saved everything you need.

Access Backup and Reset Options

1. From home, tap **Apps**  > **Settings**  > **Cloud and accounts** .

2. Tap **Backup and reset**.

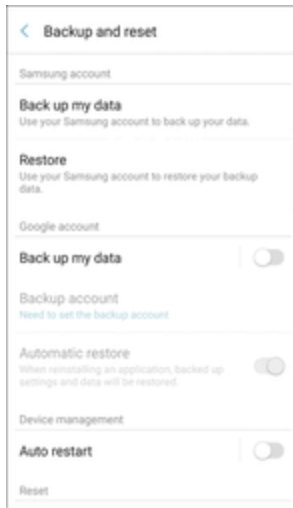

❖ The Backup and reset menu opens.

3. Set options.

❖ The backup and reset settings are applied and saved.

- If you are performing a Factory data reset, follow the prompts to confirm the data removal. The phone will erase all data and reboot.

Important: After performing a Factory data reset, you will need to sign in to the phone using the same Google Account and password previously associated with the phone. If you wish to remove this restriction, you will need to remove all Google Accounts from the phone before performing the Factory data reset. See [Factory Reset Protection](#) for details.

Samsung Account Backup Settings

Enable backup of your information to your Samsung account.

1. From home, tap **Apps**  > **Settings**  > **Cloud and accounts** .

2. Tap **Backup and reset**.

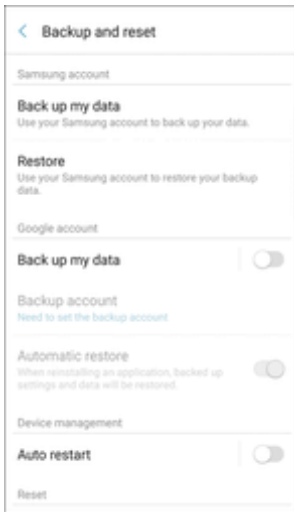

3. Configure these options:

- **Back up my data:** Enable back up of your phone log, messages and more through your Samsung account.
- **Restore:** Use your Samsung account to restore your backup data.

Google Account Backup Settings

Enable backup of your information to Google servers.

1. From home, tap **Apps**  > **Settings**  > **Cloud and accounts** .

2. Tap **Backup and reset**.

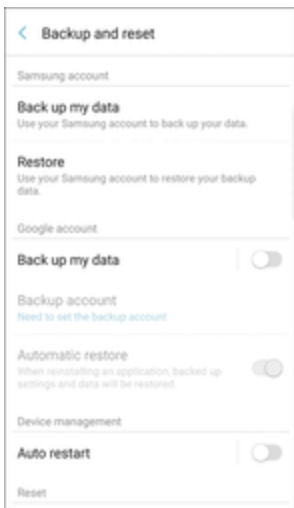

3. Configure these options:



- **Back up my data:** Enable back up of application data, Wi-Fi passwords, and other settings to Google servers.
- **Backup account:** Select a Google Account to be used as your backup account.
- **Automatic restore:** Enable automatic restoration of settings from Google servers. When enabled, backed-up settings are restored when you reinstall an application.

Auto Restart

Optimize your device by restarting it automatically at set times. The device only restarts if it is not in use and battery power is more than 30%.

Note: Any unsaved data is lost when the device restarts.

To enable Auto restart:

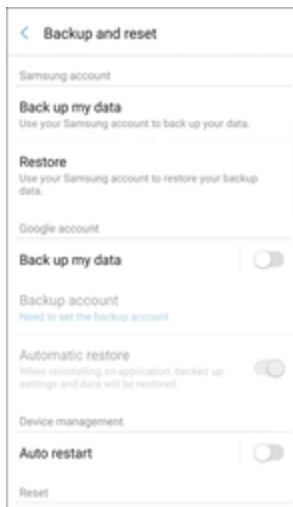

1. From home, tap **Apps**  > **Settings**  > **Cloud and accounts** .
2. Tap **Backup and reset**.



3. Tap **Auto restart**.
4. Tap **On/Off** to activate Auto restart, and then set the following parameters:
 - **Time:** Set the time of day to restart your device.
 - **Days:** Select the day of the week to automatically restart your device.

Reset Settings

You can reset your device to its factory default settings, which resets everything except the security, language, and account settings. Personal data is not affected.

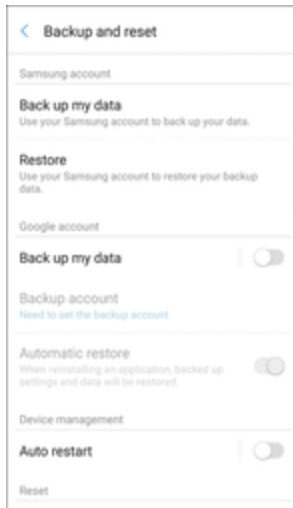

1. From home, tap **Apps**  > **Settings**  > **Cloud and accounts** .
2. Tap **Backup and reset**.



3. Tap **Reset settings**.
4. Tap **Reset settings**, and confirm when prompted.

Reset Network Settings

You can reset Wi-Fi, Mobile data, and Bluetooth settings with Reset network settings.

1. From home, tap **Apps**  > **Settings**  > **Cloud and accounts** .
2. Tap **Backup and reset**.

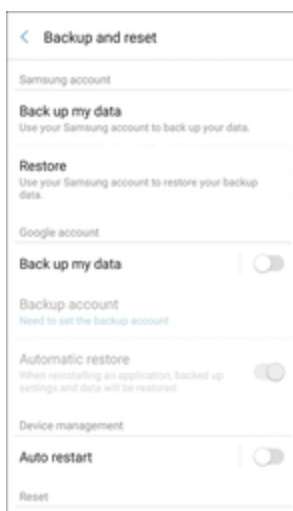

3. Tap **Reset network settings**.
4. Tap **Reset settings**, and confirm when prompted.

Factory Data Reset

Reset your device to factory defaults, erasing all data from your device.

This action permanently erases ALL data from the device, including Google or other account settings, system and application data and settings, downloaded applications, as well as your music, photos, videos, and other files. Any data found on an external SD card is not affected.

Note: When you sign in to a Google Account on your device, Factory Reset Protection is automatically activated. This protects your device in the event it is lost or stolen. For more information, see [Factory Reset Protection](#).

If you reset your device to factory default settings with the Factory Reset Protection (FRP) feature turned on, you must enter the user name and password for a registered Google Account used on this device to regain access to the device. You will not be able to access the device without the correct credentials.

Warning: If you reset your Google Account password, you must wait 72 hours after changing your password to perform a factory data reset on your device.

Before resetting your device:

1. Verify that the information you want to keep has transferred to your storage area.
2. Log in to your Google Account and confirm your user name and password.

To reset your device:

1. From home, tap **Apps**  > **Settings**  > **Cloud and accounts** .

2. Tap **Backup and reset**.

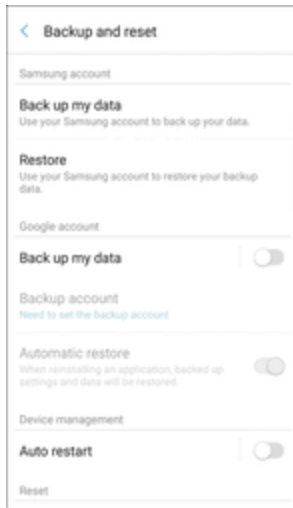



3. Tap **Factory data reset**.
4. Tap **Reset device** and follow the prompts to perform the reset.
5. When the device restarts, follow the prompts to set up your device.

Note: Unless you removed all Google Accounts from the phone before performing the Factory data reset, you will need to sign in to the Google Account that was previously assigned to the phone to complete setup.

Smart Switch Settings

Transfer content from your old device to this device.



1. From home, tap **Apps**  > **Settings**  > **Cloud and accounts** .
2. Tap **Smart Switch** and follow the prompts.

Google Settings

Configure your device's Google settings.

Customize Google

To customize your Google settings:

1. From home, tap **Apps**  > **Settings**  > **Google** .
2. Select an option to customize:

- **Sign-in & security:** Configure how you sign in to your Google Account, device access and notifications, and connected apps and sites.
- **Personal info & privacy:** Manage your personal information, activity controls, ads settings, account overview, and control your content.
- **Account preferences:** Configure your Google account language, Google Drive storage, accounts and services.
- **Nearby:** Use your device's sensors to connect with nearby devices.
- **Nearby discoveries:** Use Bluetooth and Location services to scan for links from things nearby.
- **Android Pay:** Configure your Android Pay settings.
- **Google Photos Backup:** Configure your Google Photos backup settings.
- **Location:** Configure your Google location settings.
- **Ads:** Configure your Google advertising profile.
- **Connected apps:** Configure apps which use your Google account.
- **Data management:** Configure your Google Drive app.
- **Google Fit:** Configure Google Fit apps and devices (not included).
- **Search & Now:** Configure your Google search settings and Google Now settings.
- **Security:** Configure the Android Device Manager and apps security settings.
- **Set up nearby device:** Set up another device using Wi-Fi and Bluetooth.
- **Smart Lock for Passwords:** Configure your saved Google passwords and auto sign-in settings.

Note: These options may change if you are signed in to your Google Account.

Accessibility Settings

The Accessibility menu lets you enable and manage accessibility-related applications.

Accessibility Settings Overview

The following Accessibility options may be configured:

Accessibility Option	Description
Vision	Configure accessibility features for vision.

Accessibility Option	Description
Hearing	Configure accessibility features for hearing and sounds.
Dexterity and interaction	Configure accessibility features for handling and interactions with the phone.
Direction lock	Unlock the screen by swiping in a series of directions.
Direct access	Open your accessibility settings by pressing the Home key three times in quick succession.
Notification reminder	Set the phone to beep or vibrate at set intervals to remind you of any unread notifications from selected applications.
Answering and ending calls	Answer calls by pressing the Home key, and end calls by pressing the Power key.
Single tap mode	Dismiss or snooze alarms, calendar events, and timer alerts, and answer or reject incoming calls with a single tap.
Manage accessibility	Import and export your accessibility settings, or share them with other devices.
Services	Configure other accessibility services, if installed.

Access Accessibility Options

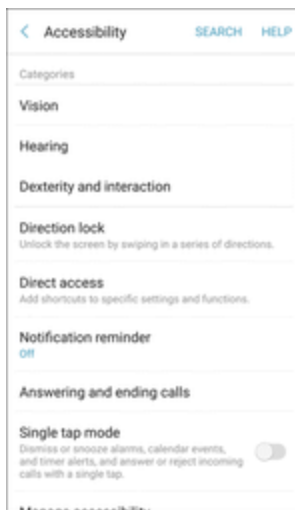

1. From home, tap **Apps**  > **Settings**  > **Accessibility** .



2. Set available accessibility options.
 - ◆ Your accessibility settings are applied and saved.

Vision Accessibility Settings



Your phone offers many features to assist users who are blind or low-vision.

1. From home, tap **Apps**  > **Settings**  > **Accessibility** .
2. Tap **Vision** to configure options:
 - **Voice Assistant:** Enable the Voice Assistant feature and configure options. When Voice Assistant is on, your phone speaks descriptions of items you tap or activate on your phone, to help blind and low-vision users. When Voice Assistant is turned on, you may need to use a double-tap to select items, because a single tap is used to trigger Voice Assistant.
 - **Voice Assistant help:** View tutorials on using Voice Assistant.
 - **Dark screen:** Keeps your phone's screen turned off at all times. When Dark screen is enabled, double-press the Power key to turn it on or off while using your phone.
 - **Rapid key input:** Release your finger to enter a selection, instead of double-tapping it. By default, when you have Voice Assistant turned on, you must double-tap items on the screen to select them. If you turn on Rapid key input, you can tap and release your finger to select an item instead of double-tapping.
 - **Speak passwords:** The phone reads out characters entered in password fields. Use caution with this feature, because others near you will be able to hear your passwords.
 - **Text-to-speech:** Configure options for converting text to speech.
 - **Accessibility shortcut:** Quickly turns on accessibility features by pressing and holding the **Power** key until you hear a sound or feel a vibration, and then pressing and holding with two fingers until you hear an audio confirmation.
 - **Voice Label:** Write voice recordings to NFC tags to provide information about nearby objects.
 - **Font size:** Choose the size of text for your phone's screens.
 - **High contrast fonts:** Adjust the color and outline of fonts to increase the contrast with the background.
 - **High contrast keyboard:** Adjust the size of the Samsung keyboard and change its colors to increase the contrast between the keys and the background.
 - **Show button shapes:** Show buttons with shaded backgrounds to make them stand out.
 - **Magnifier window:** Magnify content shown on the screen.
 - **Magnification gestures:** Control zoom and pan options with specific gestures such as triple-tapping, double pinching, and dragging two fingers across the screen.
 - **Grayscale:** Display screens in grayscale instead of color.
 - **Negative colors:** Screen colors are reversed.

- **Color adjustment:** Adjusts the color of the screen if you have difficulty reading the screen because of the color. Follow the prompts to fine-tune screen colors.



Hearing Accessibility Settings

Your phone offers many features to assist users who are deaf or hearing-impaired.

1. From home, tap **Apps**  > **Settings**  > **Accessibility** .
2. Tap **Hearing** to configure options:
 - **Sound detectors:** Vibrate when the phone detects a baby crying, doorbell ring, and more.
 - **Flash notification:** Flash the camera light when you receive notifications or when alarms sound. Turn the device over to stop the flashing.
 - **Turn off all sounds:** Sounds made by the phone during taps, selections, notifications, are muted.
 - **Hearing aids:** Automatically adjusts to attempt to improve the sound quality for use with hearing aids.
 - **Samsung subtitles (CC):** Displays Samsung subtitles where available. Tap **On/Off** to turn the option on or off, and then configure options.
 - **Google subtitles (CC):** Displays Google subtitles where available. Tap **On/Off** to turn the option on or off, and then configure options like Language, Text size, and Caption style.
 - **Left/right sound balance:** Adjust the sound sent to the left and right when using earphones.
 - **Mono audio:** Enable or disable the compression of stereo audio into a single mono audio stream for use with a single earphone.

Dexterity and Interaction Settings



Your phone offers many features to improve accessibility related to the way you interact with touch and movement.

1. From home, tap **Apps**  > **Settings**  > **Accessibility** .
2. Tap **Dexterity and interaction** to configure options:
 - **Universal switch:** Use customizable switches to interact with your phone and to select items on the screen. Set your personal interaction method by connecting external accessories, tapping the screen, or using the front camera to detect the rotation of your head, the opening of your mouth, and the blinking of your eyes.

- **Assistant menu:** Assistant menu can improve phone accessibility by providing quick access to important functions. A shortcut appears on all screens to give you access to the Assistant menu. Tap **Assistant menu** to configure options:
 - Tap **On/Off** beside Assistant menu to turn the feature on or off. When you turn on Assistant menu, Single tap mode is also enabled.
 - **Edit:** Re-order or remove items from the Assistant menu.
 - **Assistant plus:** When turned on, Assistant plus displays contextual menu options for some apps in Assistant menu. Not all apps support this option. Tap **Assistant plus**, and then tap **On/Off** to turn the option on or off. After you turn on Assistant plus, enable or disable apps to use with Assistant plus.
 - **Touchpad size:** Choose a size for touchpads for use in your phone's screens.
 - **Cursor size:** Choose the size of cursors, to display on the screen.
 - **Cursor speed:** Choose a speed for cursor blinks.
 - **Zoom percentage:** Set the percentage of zooming in when using Assistant menu.
 - **Magnifier size:** Set the size of magnification when using Assistant menu.
- **Easy screen turn on:** Move your hand over the screen to turn it on when the phone is face up on a stable surface.
- **Press and hold delay:** Choose how long your phone waits during a touch and hold gesture on the screen, before continuing with the touch and hold action.
- **Interaction control:** Control how your phone interprets motions and screen touches. To turn Interaction control on or off at any time, press and hold the Home key and the down Volume key at the same time. When Interaction control is on, you can use motions to control your phone, and screen timeout is turned on. You can also block areas of the screen from touch interaction. Automatic screen rotation and hard-key functions (Power key, Volume key, etc.) will be turned off, and app notifications will only be shown in the notification panel and status bar.

Configure Other Accessibility Settings

Your phone offers many features to improve phone accessibility.

1. From home, tap **Apps**  > **Settings**  > **Accessibility** .
2. Configure additional accessibility options:
 - **Direction lock:** Unlock the screen by swiping in a series of directions.
 - **Direct access:** Access common accessibility settings from any screen by pressing the Home key rapidly 3 times in a row.

- **Notification reminder:** Phone beeps at set intervals to remind you of unread notifications.
- **Answering and ending calls:** Select options for answering and ending calls.
 - **By pressing the Home key:** Answer calls by pressing the Home key.
 - **Using voice commands:** Say “Answer” or “Reject” to answer or reject calls with your voice.
 - **By pressing Power key:** End calls by pressing the Power key.
- **Single tap mode:** When enabled, you can use a single tap to dismiss or snooze alarms, notifications and alerts, and answer or reject calls.
- **Manage accessibility:** Choose settings for exporting, updating, and sharing the accessibility settings as a file.

Note: Additional accessibility services you have installed are displayed under the **Services** heading.



System Settings

The following topics detail your phone's system settings options, including language and input, battery, storage, date and time, and more.

General Management Settings

Configure your phone's language and input options, set the date and time, and report diagnostic information.

Access General Management Settings

1. From the home screen, tap **Apps**  > **Settings** .
2. Tap **General management** , and then tap items for more details:
 - **Language and input:** Configure your device's language and input settings.
 - **Date and time:** Configure date and time settings.
 - **Report diagnostic info:** Choose to send diagnostic information about your device to Samsung when it experiences technical issues.

Language and Input Settings



Your phone's language and input settings let you select a language for the phone's menus and keyboards, select and configure keyboard settings, configure speech input settings, and set your phone's mouse/trackpad options.

Language and Input Settings Overview

You can set the following options in the Language and input settings menu:

Language and Input Setting	Description
Language	Set the language for your display and menus.
Default keyboard	Set the default method for entering text.
Samsung keyboard	Set Samsung keyboard options.
Google voice typing	Set options for Google voice text entry.
Samsung voice input	Set options for Samsung voice input.
Language	Set the language used for handwriting recognition.
Text-to-speech	Set text-to-speech options.
Pointer speed	Set the speed of the pointer for a mouse/trackpad.

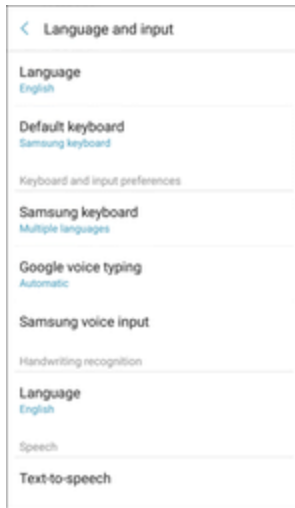

Access Language and Input Setting Options

1. From the home screen, tap **Apps**  > **Settings** .
2. Tap **General management**  > **Language and input**.





- ❖ The Language and input settings menu opens.
3. Set options.
- ❖ The language and input settings are applied and saved.

Select the Default Language for Your Phone

1. From the home screen, tap **Apps**  > **Settings** .
2. Tap **General management**  > **Language and input**.
3. The Language and input settings menu opens.
4. Tap **Language**.
5. Tap an available language.

Language and Input Options

Some of the language and input options are detailed below.

1. From the home screen, tap **Apps**  > **Settings** .
2. Tap **General management**  > **Language and input**.
3. Set options:

- **Language:** Tap a language to assign it.
- **Default keyboard:** Tap an input method to set it as the default.
- **Samsung keyboard:** Configure your keyboard options.
- **Google voice typing:** Configure your options, including language detection.
- **Samsung voice typing:** Select the language to use with Samsung voice input.
- **Language:** Handwriting can be recognized in Notes. Use this option to select a language that is used by the device to recognize your handwriting.
- **Text-to-speech:** Tap a settings option and follow the prompts.
- **Pointer speed:** Drag the bar to adjust the speed, and then tap **OK**.

Date and Time Settings

Use the Date and Time settings menu either to automatically use the network-provided date and time or manually set these values, as well as select time and date format options.

Date and Time Overview

The following Date and time options may be configured:

Date and Time Options	Description
Automatic date and time	Set the date, time, and time zone automatically using the connected wireless network.
Set date	Set the date manually (only available when Automatic date and time option is disabled).
Set time	Set the time manually (only available when Automatic date and time option is disabled).
Select time zone	Set the time zone manually (only when Automatic time zone is disabled).
Use 24-hour format	Enable or disable 24-hour time format.

Access Date and Time Options

1. From the home screen, tap **Apps**  > **Settings** .

2. Tap **General management**  > **Date and time**.



3. Set available date and time options.

❖ Your date and time settings are applied and saved.

Device Maintenance Settings

Device maintenance provides an overview of the status of your device's battery, storage, and RAM. You can also automatically optimize your device's system resources.

Device Maintenance Settings Overview

You can set the following options in the Device Maintenance Settings menu:

Device Maintenance Setting	Description
Optimize Now	Improves device performance.
Battery	Monitor your phone's battery usage.
Storage	Manage internal and optional installed SD card (not included) storage on your phone.
RAM	Check the amount of available RAM.

Optimize Now

The Optimize Now feature improves device performance. When used, it accomplishes this through the following actions:

- Identifying apps that use excessive battery power and clearing unneeded items from memory.
- Deleting unnecessary files and closing apps running in the background.

- Scanning for malware.

To use the quick optimization feature:

1. From home, tap **Apps**  > **Settings**  > **Device maintenance** .

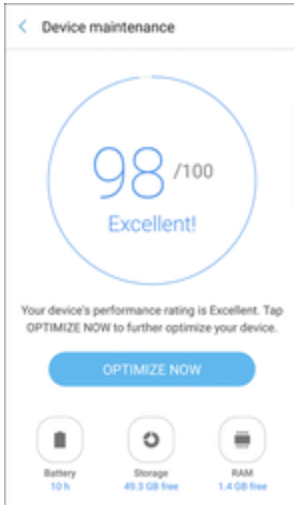

2. Tap **Optimize now**.

Battery Settings

Monitor your phone's battery usage through this settings menu. View which functions are consuming your battery's charge and at what percentage. You can also display the battery charge remaining as a percentage on the status bar.

1. From home, tap **Apps**  > **Settings**  > **Device maintenance** .

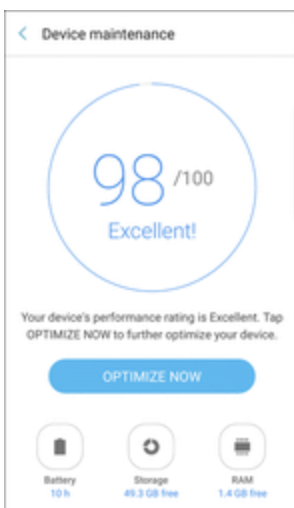

2. Tap **Battery** for options:

- **Battery usage:** View battery usage since the battery was last fully charged.
- **Power saving mode:** Extend battery life by selecting a power saving mode level. Choose **Off**, **Mid**, or **Max**. Estimated remaining battery life for each mode is provided.
- **App power monitor:** Put apps to sleep so that they do not use battery power when not in use. Tap **Save power** to enable.
- **Unmonitored apps:** Add apps that will be put to sleep.
- **More options** ⋮:
 - **Notification settings:** Configure battery notifications.
 - **Advanced settings:** Configure advanced battery settings.

Storage Settings

The Storage settings menu lets you manage internal and optional installed SD card (not included) storage on your phone.

Storage Settings Overview

The storage settings menus allows you to configure the following options:

Storage Device	Description
More options ⋮ > Internal storage	<ul style="list-style-type: none"> ■ Total space: View the total space/free space in your phone's memory. ■ Available space: The amount of storage space currently available. ■ System memory: The minimum amount of storage space required to run the system. ■ Used space: The amount of storage space currently being used. ■ Other: e space used by app data, downloaded files, and Android system files. ■ Cached data: The amount of data currently cached. ■ Explore: Launch My Files to view content stored on your device.
More options ⋮ > SD card	<p>Note: This category is available only if an optional SD card is installed.</p> <ul style="list-style-type: none"> ■ Unmount: Unmount the SD card to safely remove it. ■ Format: Delete all data on the SD card.

Access Storage Settings

1. From home, tap **Apps**  > **Settings**  > **Device maintenance** .

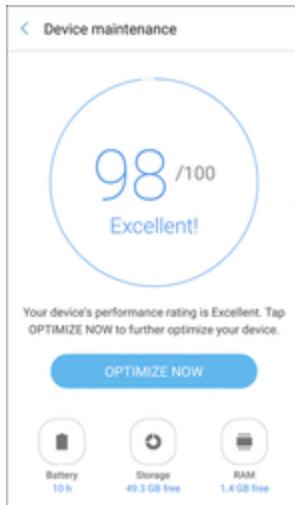

2. Tap **Storage**.

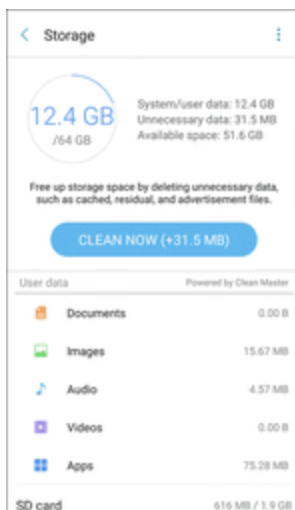

3. View memory usage for the different types of information stored in your phone's memory. Tap an item for more information.

Note: Tap **Clean now** to free up storage space by removing unneeded files.

microSD Card Settings

A microSD memory card is an optional accessory (not included) that allows you to store images, videos, music, documents, and other data on your phone.

For information about inserting or removing optional SD cards, see [SD Card](#).

Important: You can damage a microSD card by improper installation. Please be careful when inserting, removing, or handling it.

Note: To improve performance and reliability with High-definition video recording and playback, it is recommended you use a memory card (SD Card) that is both rated as at least a Class 10 and provides a high read speed.

View microSD Card Memory

Once an optional memory card (not included) has been installed in your device, the card memory is displayed as SD card.

1. From home, tap **Apps**  > **Settings**  > **Device maintenance** .

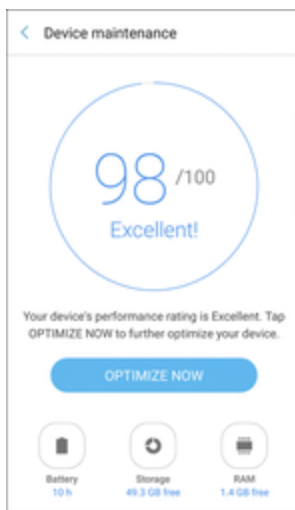

2. Tap **Storage**.

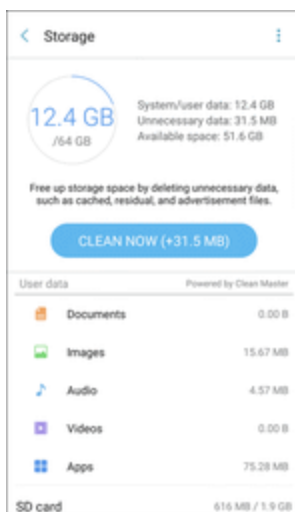

❖ The total and available memory space will be displayed.

Format a microSD Card

Formatting a microSD card permanently removes all files stored on the card.

1. From home, tap **Apps**  > **Settings**  > **Device maintenance** .

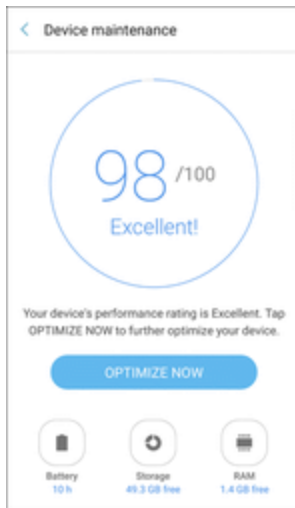

2. Tap **Storage**.

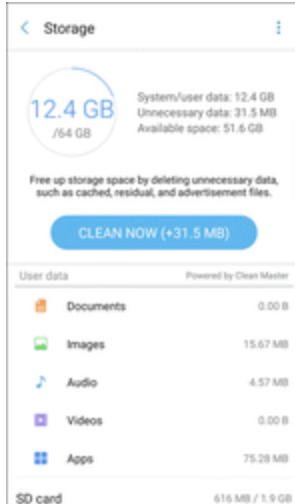

3. Tap **More options**  > **Storage settings**.
4. Tap **SD card** > **Format** > **Format**.

Note: Formatting erases all the data on an installed microSD card, after which the files CANNOT be retrieved. To prevent the loss of important data, please check the contents before you format the card.

Unmount a microSD Card

When you need to remove an optional installed microSD card, you must unmount the card first to prevent corrupting the data stored on it or damaging the card.

1. From home, tap **Apps**  > **Settings**  > **Device maintenance** .

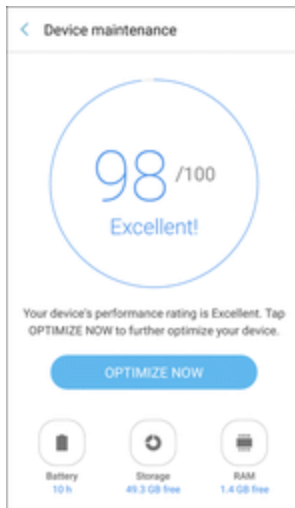

2. Tap **Storage**.

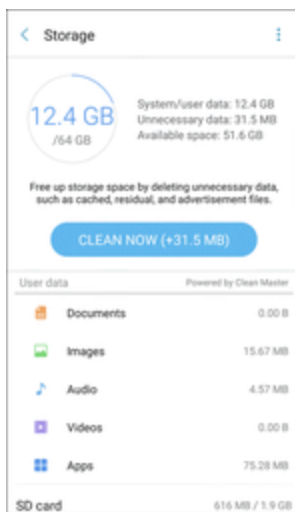

3. Tap **More options**  > **Storage settings**.
4. Tap **SD card** > **Unmount**.

Mount a microSD Card

When you install an optional memory card, it is automatically mounted (connected to the device) and prepared for use. However, should you unmount the card without removing it from the device, you need to mount it before it can be accessed.

1. From home, tap **Apps**  > **Settings**  > **Device maintenance** .

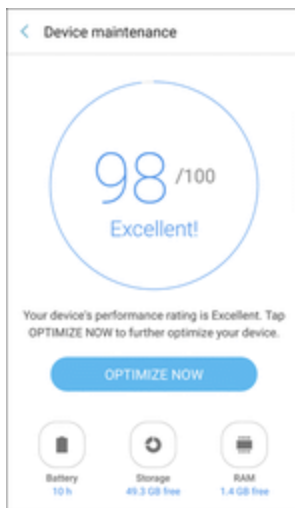

2. Tap **Storage**.

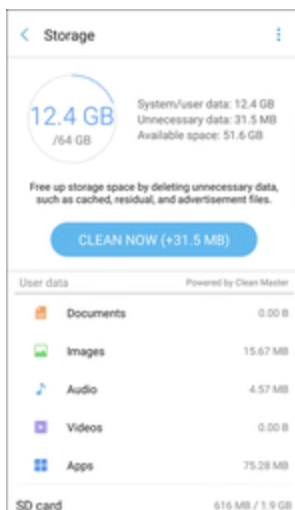

3. Tap **More options**  > **Storage settings**.
4. Tap **SD card** > **Mount**.

RAM

Check the amount of available RAM. You can close background apps and reduce the amount of RAM you are using to speed up your device.

1. From home, tap **Apps**  > **Settings**  > **Device maintenance**  > **RAM**.

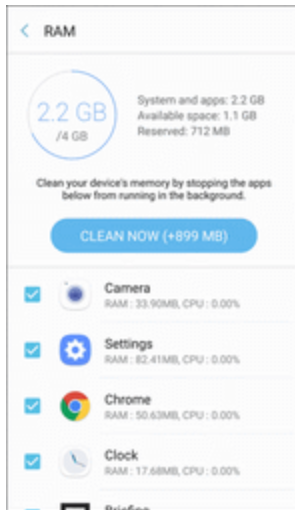

- ❖ The used and available RAM are shown.
2. To free up as much RAM as possible, tap **Clean now** and follow the prompts.
- ❖ The selected apps and services in the list will be closed.

System Update

Keep your phone up-to-date with the latest software.

Access System Updates

1. From the home screen, tap **Apps**  > **Settings** .

2. Tap **System Update** .

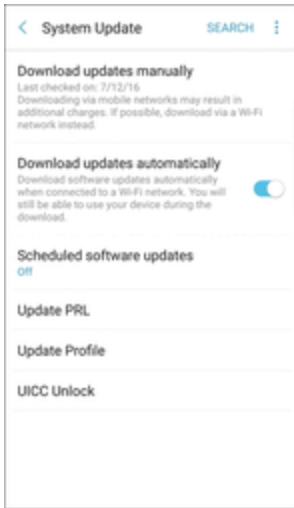



❖ The System Update menu appears.

For details about updating your phone, see [Update Your Phone](#).

Help Menu

The Help menu provides tips and guidelines to help you use your phone.

Access Help

1. From the home screen, tap **Apps**  > **Settings** .
2. Tap **Help** .

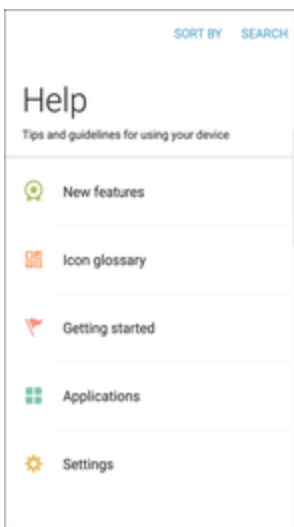

❖ The Help menu and topics appear.

3. Tap on a topic to view its contents.

4. Tap **Search** to search for a topic.

About Device

The About device menu lets you access important phone information, search for and apply updates, and view legal and safety information.



About Device Overview

The following About device items may be reviewed or set:

About Device Item	Description
Software version	View your current software version.
Hardware version	View your hardware version.
Status	Check your phone's status. <ul style="list-style-type: none">■ Battery status and level■ SIM card status (network, signal strength, mobile network type, service state, roaming, mobile network state, and phone number)■ IMEI information (MIN, PRL version, MEID, IMEI, IMEISV, and ICCID)■ IP address■ Wi-Fi MAC address■ Bluetooth address■ Up time■ Device status
Legal information	Review various types of important legal information, including Open source licenses, Google legal information, System WebView licenses, Wallpapers, Samsung legal information, and the Privacy Alert.
Device name	Change the name of your device (other devices see this name when using Mobile hotspot or Bluetooth).
Model number	Check the phone's model number.
Android version	Check the Android version number.

About Device Item	Description
Android security patch level	Check the Android security patch level.
Baseband version	Check the phone's baseband version.
Kernel version	Check the phone's kernel version.
Build number	Check the current phone build number.
SE for Android status	Check the phone's SE for Android status.
Security software version	Check the phone's security software version.
KNOX version	Check the current KNOX version.
FCC certification	Check the phone's FCC certification.
RATED	Check the phone's voltage rating.
Battery capacity	Check the phone's battery capacity.

Access About Device Options

1. From the home screen, tap **Apps**  > **Settings** .
2. Tap **About device** .



3. Select or view available options.
 - ❖ Your phone information is displayed.

Getting Help

The topics in this section will cover troubleshooting tips, phone specifications, and how to contact Sprint and manage your wireless service.

For Assistance

The following topics address areas of support for your phone, including troubleshooting, specifications, account information, warranty information, and customer service contact information.

Troubleshooting

Check the questions and answers below for troubleshooting solutions for common phone issues.

Check Here First

Problem: Phone freezes/operation is unstable.

Solution: Turn the phone on again. If you are unable to turn the phone off, remove and replace the Battery, and then turn the phone on again. Data that was being edited is erased after your phone is powered on again.

Problem: Operation is unstable after a new application was installed.

Solution: The newly installed application may be the cause. Uninstall the application in Safe mode. See [Uninstall an App](#). To turn the phone on in Safe mode:

- Press and hold the **Power key** > touch and hold **Power off**, read the disclaimer for safe mode, and then tap **OK**.
 - After turning the phone on in Safe mode, “Safe Mode” appears at lower left.
 - After restarting in Safe mode, your phone can be powered on as usual.
 - Before turning the phone on in Safe mode, it is recommended that you back up important data.
 - By powering the phone on in Safe mode, added widgets may be deleted.

Problem: Cannot use phone, mail, or Internet.

Solution 1: Check whether you are where signal is weak or out of service area.

Solution 2: Power the phone on again.

Solution 3: Is the phone in Airplane mode? To check that Airplane mode is canceled:

- From home, tap **Apps**  > **Settings**  > **Connections** > **Airplane mode**.

Solution 4: Is data communication disabled? To check that data communication is enabled:

- From home, tap **Apps**  > **Settings**  > **Connections** > **Data usage** > **Mobile data**.

Solution 5: Is a disabled access point set? To reset to initial settings:

- From home, tap **Apps**  > **Settings**  > **Connections** > **Mobile networks** > **Access Point Names** > **More** > **Reset to default**.

Problem: Battery level goes down quickly.

Solution: Are you where signal is weak or have been out of service area for a long period? Calling where signal is weak or being out of service area uses a lot of Battery.

Problem: Cannot install applications.

Solution: Applications cannot be installed with only a little free space on the phone or SD card. To check free space, see [Storage Settings](#). Applications not supported by your phone cannot be installed.

Problem: Cannot unlock screen.

Solution: Power the phone on again. If you are unable to turn the phone off, remove and replace the Battery, and then power the phone on again. Data that was being edited is erased after the phone is powered on again.

Sprint Account Information and Help

Find out about account passwords and information about managing your account and finding help.

Sprint Account Passwords

You will need to create passwords to protect access to your personal account information, your voicemail account, and your data services account. As a Sprint customer, you enjoy unlimited access to all your information.

Account User Name and Password

If you are the account owner, you will create an account user name and password when you sign on to sprint.com/mysprint. (Click **Register** and follow the prompts to get started.) If you are not the account owner (if someone else receives the bill for your Sprint service), you can get a sub-account password at sprint.com/mysprint.

Voicemail Passcode

You will create your voicemail passcode when you set up your voicemail. See [Voicemail Setup](#) for more information on your voicemail passcode.

Data Services Password

With your Sprint phone, you may elect to set up an optional data services password to control access and authorize purchases.

For more information, or to change your passwords, sign on to sprint.com/mysprint.











Manage Your Account

Manage your Sprint account from your computer, your Sprint phone, or any other phone.

Online: sprint.com/mysprint

- Access your account information.
- Check your minutes used (depending on your Sprint service plan).
- View and pay your bill.
- Enroll in Sprint online billing and automatic payment.
- Purchase accessories.
- Shop for the latest Sprint phones.
- View available Sprint service plans and options.
- Learn more about data services and other products like games, ringtones, screen savers, and more.

From Your Sprint Phone

1. From home, tap **Phone**  > **Keypad** .
2. Do any of the following:
 - Tap * 2 ( ), and then tap **Dial**  to access the Sprint Zone Self-Service page. There you can find information about Payment, Billing, Account status, and more.
 - Tap * 3 ( ), and then tap **Dial**  to access the Bill Pay Support section of Sprint Zone to make a payment.
 - Tap * 4 ( ), and then tap **Dial**  to check minute usage and account balance.







Sprint Support Services

Sprint 411 and Sprint Operator Services let you easily access information and calling assistance from your Sprint phone.

Sprint 411

Sprint 411 gives you access to a variety of services and information, including residential, business, and government listings; movie listings or show times; driving directions, restaurant reservations, and major local event information. You can get up to three pieces of information per call, and the operator can automatically connect your call at no additional charge.

There is a per-call charge to use Sprint 411, and you will be billed for airtime.

- From home, tap **Phone**  > **Keypad** , tap **4 1 1** (  ) , and then tap **Dial** .

Sprint Operator Services

Sprint Operator Services provides assistance when you place collect calls or when you place calls billed to a local telephone calling card or third party.

- From home, tap **Phone**  > **Keypad** , tap **0** () , and then tap **Dial** .

For more information or to see the latest in products and services, visit us online at sprint.com/mysprint.

Copyright Information

©2016 Sprint. Sprint and the logo are trademarks of Sprint. Other marks are trademarks of their respective owners.

WARNING! This product contains chemicals known to the State of California to cause cancer, birth defects, or other reproductive harm. For more information, please call 1-800-SAMSUNG (726-7864).

Note: Water-resistant and dust-resistant based on IP68 rating, which tests submersion up to 5.0 feet for up to 30 minutes.

Intellectual Property

All Intellectual Property, as defined below, owned by or which is otherwise the property of Samsung or its respective suppliers relating to the SAMSUNG Phone, including but not limited to, accessories, parts, or software relating there to (the “Phone System”), is proprietary to Samsung and protected under federal laws, state laws, and international treaty provisions. Intellectual Property includes, but is not limited to, inventions (patentable or unpatentable), patents, trade secrets, copyrights, software, computer programs, and related documentation and other works of authorship. You may not infringe or otherwise violate the rights secured by the Intellectual Property. Moreover, you agree that you will not (and will not attempt to) modify, prepare derivative works of, reverse engineer, decompile, disassemble, or otherwise attempt to create source code from the software. No title to or ownership in the Intellectual Property is transferred to you. All applicable rights of the Intellectual Property shall remain with SAMSUNG and its suppliers.

Open Source Software

Some software components of this product incorporate source code covered under GNU General Public License (GPL), GNU Lesser General Public License (LGPL), OpenSSL License, BSD License and other open source licenses. To obtain the source code covered under the open source licenses, please visit: opensource.samsung.com

Disclaimer of Warranties; Exclusion of Liability

EXCEPT AS SET FORTH IN THE EXPRESS WARRANTY CONTAINED ON THE WARRANTY PAGE ENCLOSED WITH THE PRODUCT, THE PURCHASER TAKES THE PRODUCT "AS IS", AND SAMSUNG MAKES NO EXPRESS OR IMPLIED WARRANTY OF ANY KIND WHATSOEVER WITH RESPECT TO THE PRODUCT, INCLUDING BUT NOT LIMITED TO THE MERCHANTABILITY OF THE PRODUCT OR ITS FITNESS FOR ANY PARTICULAR PURPOSE OR USE; THE DESIGN, CONDITION OR QUALITY OF THE PRODUCT; THE PERFORMANCE OF THE PRODUCT; THE WORKMANSHIP OF THE PRODUCT OR THE COMPONENTS CONTAINED THEREIN; OR COMPLIANCE OF THE PRODUCT WITH THE REQUIREMENTS OF ANY LAW, RULE, SPECIFICATION OR CONTRACT PERTAINING THERETO. NOTHING CONTAINED IN THE INSTRUCTION MANUAL SHALL BE CONSTRUED TO CREATE AN EXPRESS OR IMPLIED WARRANTY OF ANY KIND WHATSOEVER WITH RESPECT TO THE PRODUCT. IN ADDITION, SAMSUNG SHALL NOT BE LIABLE FOR ANY DAMAGES OF ANY KIND RESULTING FROM THE PURCHASE OR USE OF THE PRODUCT OR ARISING FROM THE BREACH OF THE EXPRESS WARRANTY, INCLUDING INCIDENTAL, SPECIAL OR CONSEQUENTIAL DAMAGES, OR LOSS OF ANTICIPATED PROFITS OR BENEFITS.

Modification of Software

SAMSUNG IS NOT LIABLE FOR PERFORMANCE ISSUES OR INCOMPATIBILITIES CAUSED BY YOUR EDITING OF REGISTRY SETTINGS, OR YOUR MODIFICATION OF OPERATING SYSTEM SOFTWARE.

USING CUSTOM OPERATING SYSTEM SOFTWARE MAY CAUSE YOUR DEVICE AND APPLICATIONS TO WORK IMPROPERLY. YOUR CARRIER MAY NOT PERMIT USERS TO DOWNLOAD CERTAIN SOFTWARE, SUCH AS CUSTOM OS.

Samsung KNOX

Samsung KNOX™ is Samsung's security platform and is a mark for a Samsung device tested for security with enterprise use in mind. Additional licensing fee may be required. For more information about KNOX, please refer to: samsung.com/us/knox [061616]

Samsung Electronics America (SEA), Inc.

Address:

85 Challenger Road
Ridgefield Park,
New Jersey 07660

Phone:

1-800-SAMSUNG (726-7864)

Internet Address:

samsung.com

©2016 Samsung Electronics America, Inc. Samsung, Samsung Galaxy, Multi Window™, S Health, S Voice, Samsung Milk Music, and Smart Switch are all trademarks of Samsung Electronics Co., Ltd.

Other marks are the property of their respective owners.

Note: Screen images are simulated. Appearance of device may vary.

Do you have questions about your Samsung Mobile Device?

For 24 hour information and assistance, we offer a new FAQ/ARS System (Automated Response System) at: samsung.com/us/support

The actual available capacity of the internal memory is less than the specified capacity because the operating system and default applications occupy part of the memory. The available capacity may change when you upgrade the device.

Legal Information

Important legal information can be accessed in writing on the mobile device or at samsung.com

READ THIS INFORMATION BEFORE USING YOUR MOBILE DEVICE.

Samsung Limited Warranty - This product is covered under the applicable Samsung Limited Warranty **INCLUDING ITS DISPUTE RESOLUTION PROCEDURE and your right to opt out of arbitration within 30 calendar days of the first consumer purchase. You may opt out by either sending an email to optout@sea.samsung.com with the subject line “Arbitration Opt-Out” or by calling 1-800-SAMSUNG (726-7864).** For more detailed procedures, please refer to the “Dispute Resolution Procedures and Arbitration and Opt-Out” section of the Limited Warranty.

Full written terms and detailed information about the warranty and obtaining service are available on the device at: **Settings > General management > Legal Information > Samsung legal** or you may access the online version of the Health/Safety and Warranty guide for your device at:

English

samsung.com/us/Legal/Phone-HSGuide

Spanish

samsung.com/us/Legal/Phone-HSGuide-SP

The online version of the **End User License Agreement (EULA)** for your device can be found online at:

samsung.com/us/Legal/SamsungLegal-EULA4

Index

3
3-way Calling 89

4
4G 136

A
About Device 312
Accessibility Settings 293
Accessory Port 7
Accounts
 Add new 284
 Manage 285
 Settings 284
Activation 18
Air Command 30
Air View 28
Airplane Mode 42, 216
Alarm 185
Amazon 196
Amazon Apps 196
Amazon Kindle 196
Amazon Music 196
Amazon Photos 196
Amazon Video 196
Answer a Call 73
App Permissions 272
App Spotlight 196
Application Manager 269
Apps
 Find and install 49
 Request refunds 50
 Uninstall 51
 Update 50
Apps Edge 25
Apps List 38
Auto Restart 289

B
Back Key 6
Backup and Reset 285
Battery
 Settings 303

Blue Light Filter 249
Bluetooth 160
 Connect 163
 Pairing 162
 Receive information 166
 Send information 164
 Settings 212
 Turn on or off 161
Bookmark 139
Brightness 247-248
Browser
 Bookmark 139
 History 140
 Launch connection 139
 Settings 142
 Tabs 141

C
Calculator 180
Calendar 181
 Add event 181
 Settings 184
 Sync 183
 Sync Exchange ActiveSync
 calendar 183
 View events 182
Call Forwarding 90
Call Log
 Make call from 78
Call Settings 91
Call Waiting 88
Caller ID Blocking 88
Camera 169
 Settings 175
 Shooting mode 172
 Switch 175
 Take a picture 171
 Viewfinder 169
Car Kit
 Connect 163
Charger/Accessory Port 7
Chrome 143
Clock 185
 Alarm 185
 Stopwatch 186

- Timer 187
- World Clock 186
- Conference Calling 89
- Contacts 94
 - Add contact 94
 - Back up 107
 - Delete 99
 - Edit 98
 - Favorites 100
 - Groups 101
 - Import 107
 - Make call from 77
 - Profile sharing 105
 - Save a phone number 96
 - Settings 108
 - Share 103
 - View 96
- Content Scaling 256
- Credential Storage 282

D

- Data Services 136
 - Password 316
 - Status indicators 138
 - User name 137
- Data Usage Settings 215
- Date Settings 301
- Default Applications 271
- Device Administration 281
- Device Visibility 214
- Dexterity and Interaction Settings 296
- Do Not Disturb 241
- Drag 16
- Drive (App) 187

E

- Edge Feeds 26
- Edge Lighting 26
- Edge Screen 24
 - Settings 250
- Editing Text 45
- Email 124
 - Add account 125
 - Add Exchange ActiveSync account 127
 - Delete account 130
 - Manage inbox 130
 - Send Gmail 118
 - Send message 128

- Settings 133
- Setup 124
- View and reply 129
- Emergency Numbers 72
- Enhanced 9-1-1 (E 9-1-1) 73
- Enter Text 42
- Exchange ActiveSync
 - Add account 127
 - Features 131
- Extended Home Screen 58

F

- Facebook 144
- Factory Data Reset 291
- Factory Reset Protection 47
- Favorites 100
- Files
 - Transfer between phone and computer 155
- Fingerprint Screen Lock 278
- Flash 6
- Flick 17
- Folders 68
- Font 250

G

- Galaxy Apps 197
- Gallery 173
 - View pictures and videos 174
- Games
 - Manage 265
- Global Roaming Mode 148
- Gmail 117
 - Add account 122
 - Archive threads 121
 - Create account 45
 - Delete threads 122
 - Labels 120
 - Mute threads 121
 - New messages 119
 - Read and reply 119
 - Read messages 119
 - Report spam 122
 - Search 122
 - Send message 118
 - Settings 123
 - Switch accounts 123

Google
 Chrome 143
 Create account 45
 Drive 187
 Hangouts 144
 Photos 190
 Search 188
 Settings 292
 Sign in 47
 Google Account
 Backup 288
 Google Maps 187
 Google Play
 Find and install apps 49
 Help 52
 Store 48
 Google Play Music 197
 Groups 101

H

Hangouts 144
 Headset
 Connect 163
 Headset Jack 7
 Hearing Accessibility 296
 Help Menu 311
 Home Screen 57
 Add Folders 68
 Add Shortcuts 67
 Add Widgets 68
 Customize 66
 Extended 58
 Hotspot 159
 Settings 230

I

Icon Frames 258
 Icons 274
 Import Contacts 107
 Incoming Call
 Answer 73
 Reject 74
 Input Settings 299
 Instagram 146
 International Data Roaming 152
 Iris Scan Screen Lock 279

K

Key-tap Feedback 244
 Keyboard
 Samsung keyboard 42

L

Language Settings 299
 LED Indicator 262
 Live Broadcast 177
 Live Soccer & TV 200
 Lookout 189

M

Maps 187
 Memory 304
 Memory Card 305
 Messages
 Settings 116
 Messaging 110
 Messenger 146
 Micro-USB Connector 9
 microSD Card 305
 Format 307
 Mount 309
 Unmount 308
 View available memory 306
 MMS
 Send messages 111
 Mobile Hotspot 159
 Mobile Networks Settings 218
 Multi Window 65
 Music
 Google Play Music 197
 Sprint Music Plus 203
 My Files 189

N

Nearby Device Scanning 223
 NextRadio 200
 NFC and Payment 216
 Night Clock 260
 Notification Icons 60
 Notification Panel 61
 Notification Sounds 240
 Notifications 60, 246

O

One-Handed Operation 266
 Optimize Now 302

P

PEN.UP 200
 People Edge 26
 Phone
 Dialer 71
 Phone Calls 71
 Answer 73
 Emergency numbers 72
 Using Call Log 78
 Using contacts 77
 Using phone keypad 71
 Phone Layout (illustration) 5
 Phone Number 42
 Save to contacts 96
 Phone Update
 Software 54
 Photos 190
 Pictures
 Take with camera 171
 View 174
 Pinch 18
 Play Music 197
 Play Store 48
 Find and install apps 49
 Plus (+) Code Dialing 149
 Power Off 14
 Power On 13
 Printing 224

Q

Quick Settings 62

R

Recent Apps 22
 Reject Incoming Call 74
 Reverse Charging 8
 Ringtone 234
 Ringtones
 Settings 238
 Rotate 17

S

S Health 200
 S Pen 27
 Air Command 30
 Removing 27
 Replace tip 29
 Screen Write 33
 Settings 264
 Smart Select 32
 Translate 34
 S Voice 190
 Settings 191
 Samsung Account
 Backup 287
 Samsung Cloud 283
 Samsung Gear 191
 Samsung Keyboard 42
 Samsung Notes 191
 Samsung Pay 193
 Samsung Voice Input 44
 Samsung+ 202
 Save a Phone Number 96
 Screen Lock 276
 Screen Mode 261
 Screen Off Memo 29, 31
 Screen Rotation 23
 Screen Saver 263
 Screen Timeout 247, 259
 Screen Unlock
 Fingerprint 278
 Iris scan 279
 Motion 277
 Password 278
 Pattern 277
 PIN 278
 Swipe 277
 Screen Write 33
 Screenshots 24
 SD Card 11, 305
 Encrypt 281
 Format 13
 Insert 11
 Remove 12
 Unmount 12
 Search 64
 Secure Credential Storage 225
 Secure Folder 280
 Secure Startup 280

- Settings
 - Overview 208
- Setup Screens 19
- Share
 - Contacts 103
- SIM Card 10, 147
- Slide 16
- Smart Select 32
- Smart Stay 265
- Smart Switch 20
- Smart Switch Settings 292
- Sound Mode 235
- Speaker 7
- Spread 18
- Sprint 411 317
- Sprint Account
 - Management 317
 - Passwords 316
- Sprint Family Locator 194
- Sprint Fun & Games 202
- Sprint Music Plus 203
- Sprint Operator Services 318
- Sprint TV & Movies 204
- Sprint Worldwide Wireless Service 147
- Sprint Zone 204
- Status Bar 58
- Status Icons 59
- Stopwatch 186
- Storage
 - Settings 304
- Swipe 16
- System Sounds 243
- System Update 310

T

- Tap 15
- Tap and Pay 218
- Tasks Edge 25
- Tech Expert 194
- Tethering 167
- Tethering Settings 232
- Text Editing 45
- Text Entry 42
- Text Messaging
 - Conversations 114
 - Draft messages 113
 - Notifications 113
 - Send messages 110
- Themes 273

- Time Settings 301
- Timer 187
- Touch 15
- Touch and Hold 15
- Touchscreen
 - Turn off 53
 - Turn on 53
- Translate 34
- Troubleshooting 315
- TTY Mode 93
- Turn Device Off 14
- Turn Phone On 13
- Typing 42

U

- Uber 195
- Unknown Sources 280

V

- Vibrate
 - Intensity 238
 - While Ringing 236
- Vibration Pattern 240
- Video Camera
 - Record video 171
- Videos
 - Record 171
 - View 174
- Vision Accessibility 294
- Visual Voicemail 80
 - Options 82
 - Review 81
 - Settings 84
 - Setup 80
- Voice Typing 44
- Voicemail
 - Display name 86
 - Greeting 85
 - International 150
 - Passcode 316
 - Setup 79
- Volume 234, 237
 - Key 6
- VPN 225
 - Add connection 226
 - Connect or disconnect 227
 - Prepare for connection 225
 - Secure credential storage 225

W

- Wallpaper 66
- Wallpaper Settings 273
- Web
 - Launch connection 139
- Wi-Fi 156
 - Disconnect 158
 - Settings 158, 210
 - Turn on and connect 157
- Wi-Fi Calling 87
 - Settings 229
- Wi-Fi Direct 158
- Widgets 68
- World Clock 186

Y

- YouTube 205

Z

- Zoom 18